

A Revision of the Genera
Pelomyia Williston
and *Masoniella* Vockeroth
(Diptera: Tethinidae)

GEORGE A. FOSTER
and
WAYNE N. MATHIS

SERIES PUBLICATIONS OF THE SMITHSONIAN INSTITUTION

Emphasis upon publication as a means of "diffusing knowledge" was expressed by the first Secretary of the Smithsonian. In his formal plan for the Institution, Joseph Henry outlined a program that included the following statement: "It is proposed to publish a series of reports, giving an account of the new discoveries in science, and of the changes made from year to year in all branches of knowledge." This theme of basic research has been adhered to through the years by thousands of titles issued in series publications under the Smithsonian imprint, commencing with *Smithsonian Contributions to Knowledge* in 1848 and continuing with the following active series:

Smithsonian Contributions to Anthropology
Smithsonian Contributions to Botany
Smithsonian Contributions to the Earth Sciences
Smithsonian Contributions to the Marine Sciences
Smithsonian Contributions to Paleobiology
Smithsonian Contributions to Zoology
Smithsonian Folklife Studies
Smithsonian Studies in Air and Space
Smithsonian Studies in History and Technology

In these series, the Institution publishes small papers and full-scale monographs that report the research and collections of its various museums and bureaux or of professional colleagues in the world of science and scholarship. The publications are distributed by mailing lists to libraries, universities, and similar institutions throughout the world.

Papers or monographs submitted for series publication are received by the Smithsonian Institution Press, subject to its own review for format and style, only through departments of the various Smithsonian museums or bureaux, where the manuscripts are given substantive review. Press requirements for manuscript and art preparation are outlined on the inside back cover.

Lawrence M. Small
Secretary
Smithsonian Institution

SMITHSONIAN CONTRIBUTIONS TO ZOOLOGY • NUMBER 619

A Revision of the Genera
Pelomyia Williston and *Masoniella* Vockeroth
(Diptera: Tethinidae)

George A. Foster and Wayne N. Mathis



Smithsonian Contributions and Studies Series

AN IMPRINT OF SMITHSONIAN BOOKS

Washington, D.C.

2003

ABSTRACT

George A. Foster and Wayne N. Mathis. A Revision of the Genera *Pelomyia* Williston and *Masoniella* Vockeroth (Diptera: Tethinidae). *Smithsonian Contributions to Zoology*, number 619, 63 pages, 79 figures, 4 tables, 2003.—Twenty-four new species are described in two genera (type locality in parentheses): *Pelomyia granditarsa* (Nevada, USA), *P. lobina* (Montana, USA), *P. planibulla* (Washington, USA), *P. dentata* (Jujuy, Argentina), *P. aurantifrons* (Cuzco, Peru), *P. irwini* (Huánuco, Peru), *P. nigratarsis* (Jujuy, Argentina), *P. robustiseta* (Jujuy, Argentina), *P. vockerothi* (Jujuy, Argentina), *P. freidbergi* (La Paz, Bolivia), *P. curva* (Cochabamba, Bolivia), *P. univittata* (Oruro, Bolivia), *P. nigripalpis* (Oruro, Bolivia), *P. undulata* (Oruro, Bolivia), *P. boliviensis* (Cochabamba, Bolivia), *P. crassiseta* (Aysén, Chile), *P. crassispina* (Jujuy, Argentina), *P. griseocoxa* (Curicó, Chile), *P. melanocera* (Osorno, Chile), *Masoniella advena* (Jujuy, Argentina), *M. argentinaensis* (Argentina), *M. delicata* (Moquegua, Peru), *M. flabella* (Salta, Argentina), and *M. spatulata* (Aysén, Chile).

The cladistic analysis was done in two steps: first at the level of genera within Pelomyiinae and second for species within *Pelomyia*. The cladistic analysis of genera within Pelomyiinae was based upon 19 morphological characters and resulted in a single most-parsimonious cladogram of 11 steps with consistency and retention indices of 1.0 and 1.0, respectively. The four genera composing the subfamily Pelomyiinae are divided into two lineages in the cladogram: *Masoniella* plus *Pelomyia* as the sister group to *Neopelomyia* plus *Pelomyiella*.

Keys at various taxonomic levels are provided as follows: the genera of Pelomyiinae, the species groups of *Pelomyia*, the species of the *coronata* group (separate keys to males and females), the species of the *melanocera* group (combined key to males and females), and the species of *Masoniella* (combined key to males and females).

OFFICIAL PUBLICATION DATE is handstamped in a limited number of initial copies and is recorded in the Institution's annual report, *Annals of the Smithsonian Institution*. SERIES COVER DESIGN: The coral *Montastrea cavernosa* (Linnaeus).

Library of Congress Cataloging-in-Publication Data

Foster, G. A. (George Alan), 1953—

A revision of the genera *Pelomyia* Williston and *Masoniella* Vockeroth

(Diptera: Tethinidae) / George A. Foster and Wayne N. Mathis.

p. cm. — (Smithsonian contributions to zoology ; no. 619)

Includes bibliographical references.

1. *Pelomyia*—Classification. 2. *Masoniella*—Classification. I. Mathis, Wayne N.

II. Title. III. Series.

QL1.S54 no. 619

[QL537.T448]

590 s—dc21

[595.774]

2003042367

∞ The paper used in this publication meets the minimum requirements of the American National Standard for Permanence of Paper for Printed Library Materials Z39.48—1984.

Contents

| | <i>Page</i> |
|--|-------------|
| Introduction | 1 |
| Methods and Material | 2 |
| Acknowledgments | 2 |
| Systematics | 2 |
| Subfamily PELOMYIINAE Foster | 2 |
| Key to Genera of the Subfamily PELOMYIINAE | 3 |
| Genus <i>Pelomyia</i> Williston | 4 |
| Key to Species Groups of <i>Pelomyia</i> Williston | 6 |
| The <i>coronata</i> Group | 6 |
| Key to Males of the <i>coronata</i> Group | 7 |
| Key to Known Females of the <i>coronata</i> Group | 9 |
| 1. <i>Pelomyia coronata</i> (Loew) | 9 |
| 2. <i>Pelomyia granditarsa</i> , new species | 14 |
| 3. <i>Pelomyia lobina</i> , new species | 15 |
| 4. <i>Pelomyia nubila</i> Melander | 16 |
| 5. <i>Pelomyia occidentalis</i> Williston | 17 |
| 6. <i>Pelomyia intermedia</i> Malloch | 22 |
| 7. <i>Pelomyia planibulla</i> , new species | 23 |
| 8. <i>Pelomyia dentata</i> , new species | 24 |
| 9. <i>Pelomyia aurantifrons</i> , new species | 26 |
| 10. <i>Pelomyia irwini</i> , new species | 28 |
| 11. <i>Pelomyia nigritarsis</i> , new species | 29 |
| 12. <i>Pelomyia peruviana</i> Malloch | 30 |
| 13. <i>Pelomyia robustiseta</i> , new species | 31 |
| 14. <i>Pelomyia trivittata</i> Malloch | 32 |
| 15. <i>Pelomyia viedmae</i> Malloch | 34 |
| 16. <i>Pelomyia vockerothi</i> , new species | 35 |
| 17. <i>Pelomyia freidbergi</i> , new species | 37 |
| 18. <i>Pelomyia curva</i> , new species | 38 |
| 19. <i>Pelomyia univittata</i> , new species | 39 |
| 20. <i>Pelomyia nigripalpis</i> , new species | 41 |
| 21. <i>Pelomyia undulata</i> , new species | 42 |
| 22. <i>Pelomyia boliviensis</i> , new species | 42 |
| The <i>melanocera</i> Group | 43 |
| Key to Species of the <i>melanocera</i> Group | 44 |
| 23. <i>Pelomyia crassiseta</i> , new species | 44 |
| 24. <i>Pelomyia crassispina</i> , new species | 46 |
| 25. <i>Pelomyia grisecoxa</i> , new species | 47 |
| 26. <i>Pelomyia melanocera</i> , new species | 48 |
| 27. <i>Pelomyia</i> species | 49 |
| Genus <i>Masoniella</i> Vockeroth | 49 |
| Key to Species of <i>Masoniella</i> Vockeroth | 50 |
| 28. <i>Masoniella advena</i> , new species | 50 |
| 29. <i>Masoniella argentinaensis</i> , new species | 52 |
| 30. <i>Masoniella delicata</i> , new species | 53 |
| 31. <i>Masoniella flabella</i> , new species | 54 |

| | |
|---|----|
| 32. <i>Masoniella richardsi</i> Vockeroth | 55 |
| 33. <i>Masoniella spatulata</i> , new species | 56 |
| Phylogenetic Considerations | 57 |
| Characters Used in the Phylogenetic Analysis of the Four Genera within Subfamily Pelomyiinae | 58 |
| Characters Used in the Phylogenetic Analysis of Species Groups within <i>Pelomyia</i> ... | 58 |
| Distributional and Biogeographic Considerations | 61 |
| Literature Cited | 62 |

A Revision of the Genera *Pelomyia* Williston and *Masoniella* Vockeroth (Diptera: Tethinidae)

George A. Foster and Wayne N. Mathis

Introduction

This paper is a revision of the genera *Pelomyia* Williston and *Masoniella* Vockeroth, with an emphasis on taxa occurring in the New World. Our study of these genera was prompted by discovery of several new species, primarily from North and South America, during a comprehensive phylogenetic review of the families Canacidae and Tethinidae—specifically, the subfamily Pelomyiinae. Describing these new species within a phylogenetic context is the primary objective of this paper.

Williston (1893) described *Pelomyia* in a list of dipterous species from Death Valley and other parts of California. He based his generic description on the type species, *Pelomyia occidentalis*, which was represented by two specimens collected in Monterey, California. Twenty years later, Melander (1913b) concluded that *P. occidentalis* and *Tethina coronata* Loew were conspecific, and in his key to species of *Tethina* Haliday, the two species' names were synonymized. Earlier that same year, however, Melander (1913a:229) had already noted that *Pelomyia* and *Tethina* resembled each other and wrote that "Professor [John Merton] Aldrich first suggested to me the identity of *Pelomyia* Williston with *Tethina*."¹ Thus at Aldrich's suggestion, Melander synonymized *Pelomyia* with *Tethina*.

When Malloch (1913) distinguished "*Rhinoessa* Loew" from "*Tethina*," he placed the following species in *Tethina*: *T. rostrata* Hendel, *T. coronata* Loew, and *T. parvula* Loew. These three species are currently in three different genera, *Neopelomyia* Hendel, *Pelomyia*, and *Tethina*, respectively. Malloch did not review *P. occidentalis*.

Hendel (1917:46) accorded separate generic status again to *Pelomyia* but retained Melander's (1913b) synonymy of *P. occidentalis* with *P. coronata* (Loew). It is noteworthy that no author at that point had examined the primary types of *P. coronata* or *P. occidentalis*.

Sturtevant (1923) confirmed Melander's synonymy of *P. occidentalis* with *P. coronata* after studying the types of both species (see notes in the treatment of these species). Sturtevant also included in *Pelomyia* the new species *P. mallochi*, *P. maritima*, and *P. melanderi*. These species are now in *Pelomyiella* Hendel. Sturtevant recognized only three genera, *Neopelomyia*, *Pelomyia*, and *Tethina*, and all were placed in Geomyzinae (family Muscidae).

Czerny (1928) recognized only *Pelomyia* and *Tethina* as genera of Tethinidae in his treatment of the Palearctic fauna. The species he placed in *Pelomyia* were *P. cinerella* and two new species, *P. kuntzei* and *P. hungarica*. These three species are also now in *Pelomyiella*.

Hendel (1934), in his revision of Tethinidae, continued to recognize *Pelomyia* as a valid genus and provided a key to *P. coronata* and a new species, *P. cruciata*. He retained the synonymy of *P. occidentalis* with *P. coronata* but did not study the type material.

Melander (1952) contributed the latest study of *Pelomyia* in his review of the North American species of Tethinidae. In addition to a review, Melander described one new species, *P. nubila*. Like Hendel, Melander did not examine the type material.

George A. Foster and Wayne N. Mathis, Department of Systematic Biology, Entomology Section, National Museum of Natural History, Smithsonian Institution, Washington, D.C. 20560-0169, USA.

Review Chairperson: John M. Burns, Department of Systematic Biology, Entomology Section, National Museum of Natural History, Smithsonian Institution, Washington, D.C. 20560-0127, USA.

Reviewers: Anthony G. Irwin, Department of Natural History, Castle Museum, Norwich, Norfolk NR1 3JU, United Kingdom; Lorenzo Munari, c/o Laboratory of Entomology, Museo Civico di Storia Naturale, Fontego dei Turchi, I-30135, Venezia, Italy; and J. Richard Vockeroth, Centre for Land and Biological Resources Research, Central Experimental Farm, Ottawa, Ontario K1A 0C6, Canada.

¹John Merton Aldrich was an entomologist with the former United States National Museum.

Sturtevant, then, is the only worker to have studied any type material of *Pelomyia*, and he did not comment on structures of the male genitalia. Thus, the identity of the types he examined is questionable. Our study clarifies much of the confusion about the species of *Pelomyia* through detailed study of hundreds of specimens, including all primary types.

The nomenclatural history of *Masoniella* is much more recent (Vockeroth, 1987, 1995) and, as a result, more concise. The genus was first described and beautifully illustrated in a manual dealing with all genera of North American Diptera (Vockeroth, 1987). Unfortunately, the name at that time was unavailable and was a nomen nudum, not fulfilling all requirements of the zoological code of nomenclature. Vockeroth (1995) corrected this lapse and validated both the generic and species names. *Masoniella* was included in the world catalog of Mathis and Munari (1996), and until now, the genus has been monotypic, with *M. richardsi* Vockeroth as its only included species. Mathis and Munari treated *Masoniella* in the subfamily Tethininae, but our study reveals that the genus is closely related to *Pelomyia* and is herein transferred to Pelomyiinae. Within this paper we describe five additional species from specimens collected in the neotropics. *Masoniella* is known thus far only from the New World.

METHODS AND MATERIAL.—The descriptive terminology for external structures and many internal structures follows that published in the *Manual of Nearctic Diptera* (McAlpine, 1981). For structures of the male terminalia, however, we have adopted the terminology suggested by Cumming et al. (1995). Because the specimens are small (usually less than 4 mm in length), their study and illustration required the use of dissecting and compound microscopes. Structures of the male terminalia are labeled on Figures 1–10, 42, 65, 69, and 70 and are not repeated on comparable illustrations of other species. The descriptions of new species are based primarily upon their respective holotypes, with variation accounted for in the “Remarks” sections. The following ratios used in the descriptions represent the averages of three specimens—the largest, the smallest, and one other.

1. Gena-to-eye ratio is the genal height, measured at the maximum eye height, divided by the eye height.
2. Costal section ratios are presented as the relative straight line distance between the apices of the subcosta and vein R_1 : the distance between the apices of R_1 and R_{2+3} : and the distance between the apices R_{2+3} and R_{4+5} .

The phylogenetic analysis was performed with the assistance of Hennig86©, a computerized algorithm that produces cladograms by parsimony. Before analysis, character data were arranged in transformation series and then polarized, primarily using outgroup procedures. Although autapomorphies were not included in the cladistic analysis (they were made inactive), as they would have skewed the consistency and retention indices, we list them on the cladogram and include them as part of ge-

neric treatments and phylogenetic considerations to document the monophyly of the lineages, particularly at the generic level.

ACKNOWLEDGMENTS.—Although this study was based primarily upon specimens in the Canadian National Collection and the National Museum of Natural History, Smithsonian Institution, numerous other specimens were borrowed, particularly type specimens of previously described species. To our colleagues and their institutions listed below who loaned specimens, we express our sincere thanks. Without their cooperation this study could not have been completed.

| | |
|------|---|
| AMNH | American Museum of Natural History, New York, New York (David A. Grimaldi and Julian Stark) |
| BMNH | The Natural History Museum, London, England (John E. Chainey) |
| CAS | California Academy of Sciences, San Francisco, California (Paul H. Arnaud, Jr.) |
| CNC | Canadian National Collection, Ottawa, Canada (J. Richard Vockeroth and Jeff M. Cumming) |
| GUE | University of Guelph, Guelph, Ontario, Canada (Stephen A. Marshall) |
| MCZ | Museum of Comparative Zoology, Harvard University, Cambridge, Massachusetts (Philip D. Perkins) |
| MNBL | Museo Nacional de Historia Natural, La Paz, Bolivia (Alvaro Garitano-Zavala) |
| NMW | Naturhistorisches Museum, Vienna, Austria (Ruth Contreras-Lichtenberg) |
| USNM | Collections of the National Museum of Natural History, Smithsonian Institution, Washington, D.C., including those of the former United States National Museum |

Paul H. Arnaud, Jr., provided assistance with locality information, especially poorly known sites in the western United States, and Anthony G. Irwin graciously made available to us his notes from his own research on Tethinidae, specifically *Pelomyia*.

Field work in Peru was greatly expedited through the able and pleasant assistance of Oliver S. Flint, Jr., and Wayne E. Clark, and we are grateful also to David Challinor (former Assistant Secretary for Research, Smithsonian Institution) for financial support to conduct this field work.

Field work in Bolivia was funded primarily by grants from the Biodiversity Program (Biotic Surveys and Inventories, BSI), National Museum of Natural History, Smithsonian Institution (George R. Zug, chairperson).

The illustrations were carefully inked by Young T. Sohn from pencil drawings prepared by the first author. For reviewing a draft of this paper we thank Lorenzo Munari, Anthony G. Irwin, and J. Richard Vockeroth.

Systematics

Subfamily PELOMYIINAE Foster

Pelomyiinae Foster, 1976a:337 [type genus: *Pelomyia* Williston, 1893].

DIAGNOSIS.—Genera of the subfamily Pelomyiinae are distinguished from other genera in the family Tethinidae by the following combination of characters.

Head: Usually as high as long (elongate in *Neopelomyia*); paravertic setae weak, convergent, or proclinate; convergent inner vertical seta 1; divergent outer vertical seta 1; strong ocellar seta 1, with additional (sometimes several) minute setulae; fronto-orbital setae 1–3; frons at most with a few minute setulae, often bare; parafrons with a few minute setulae (in *Pelomyia* with a stronger setula near antennal base). Antenna semiporrect; arista sparsely micropubescent. Face narrow, membranous; oral vibrissae strong to absent. Gena bearing many scattered setulae; distinct peristomal row absent or present; shiny chitinous stripe along parafacial margins, peristoma absent or present; labellum long or short; maxillary palpus shorter than oral cavity, bearing 1 strong, apical seta or several scattered setae.

Thorax: With gray to brown microtomentum; dorsocentral setae 4 (1+3); scutellar setae 2; acrostichal setulae few or absent—if present, weak and in 2–4 scattered rows. Disk of scutellum bare. Wing with crossvein bm-cu usually absent; wing venation typical acalyptrate pattern. Legs: forecoxa long and slender; fore- and hindfemora often moderately enlarged; forefemur with row of strong setae on posterodorsal and posteroventral surface, anteriorly often with comb of weak to very strong setae on anteroventral surface, otherwise evenly setulose; mid- and hindfemora, tibiae, and tarsi more or less evenly setulose; midfemur sometimes bearing 1 stronger seta in middle of anterior surface; proepisternal seta 1; proepimeral seta 1.

Abdomen: With brown or gray microtomentum; extreme posterior margin of tergites usually pale. Male terminalia: epandrium with distinct ventral lobe of various shapes, bifurcate in some species of *Pelomyia*, usually setulose on medial surface, possibly setulose on anterior or posterior margin or both; surstylus usually rather straight and shorter than cercus,

setulose; surstylus laterad to cercus, articulating strongly with subepandrial sclerite; additional anterior lobe present in one species of *Masoniella*; cercus evenly setulose, with 1 long, strong apical seta; hypandrium with 2 arms fused anteriorly with aedeagal apodeme, separated posteriorly but articulated with subepandrial sclerite and epandrium; hypandrial apodeme absent; basiphallus oblong, ovoid, or triangular; pregonites distinct or fused with hypandrium; if fused, some setae remaining on hypandrium, showing location of pregonites; if pregonites distinct, often extended posteriorly as pair of spatulate or pointed processes partially fused with postgonites; postgonites typically long, pointed, or spatulate posteriorly, sometimes fused together posteriorly; articulated with aedeagal apodeme anteriorly (may have a nodulate flexion point medially if separate); if fused or nearly fused together posteriorly (as in *Neopelomyia* and *Pelomyiella*, respectively), then dentate or nodulate over the posterior half or so; aedeagus usually long and densely setulose. Female terminalia: typical for Tethinidae except cercus sometimes bearing thick, blunt, spine-like setae.

DISTRIBUTION.—With the exception of *Pelomyiella*, which is Holarctic in distribution, the genera of Pelomyiinae are found primarily in the New World. The genera *Masoniella*, *Neopelomyia*, and *Pelomyia* occur exclusively in the New World with the exception of *P. occidentalis*, which is apparently adventive to central Europe (Roháček, 1992; and species treatment below).

DISCUSSION.—Synapomorphies that demonstrate the monophyly of Pelomyiinae are (only derived state cited) (1) crossvein bm-cu generally absent, (2) surstylus shifted dorsally, (3) gena setose, (4) acrostichal setae reduced or absent, and (5) internal copulatory apparatus complex (well-developed pregonites; postgonites may be bilobed, dentate, or fused).

Key to Genera of the Subfamily PELOMYIINAE

1. Paravertic setae proclinate; lacking forefemoral comb of setae along anteroventral surface; peristomal and parafacial margins with at most a remnant of a shiny chitinous stripe 2
 - Paravertic setae convergent; forefemur usually bearing an anteroventral ctenidial comb; peristomal and parafacial margins with a distinct, shiny chitinous stripe 3
2. Head elongate, longer than high; eye oblique; ventral portion of face protrudent; fronto-orbital setae 3; oral vibrissae strong; distinct peristomal setae absent; labellum elongate; palpus with many fine setae *Neopelomyia* Hendel
 - Head at least as high as long; eye round; face vertical; fronto-orbital setae 1 or 2; oral vibrissae weak to absent; peristomal setae distinct; labellum short; palpus with only 1 weak seta *Pelomyiella* Hendel
3. Body robust; always evenly microtomentose; gena rarely less than 0.20 times eye height *Pelomyia* Williston
 - Body usually smaller, delicate; thorax sometimes shiny; abdomen shiny (except *P. argentinaensis*); gena usually less than 0.20 times eye height (except *P. advena*, 0.25) *Masoniella* Vockeroth

Genus *Pelomyia* Williston

Pelomyia Williston, 1893:258 [type species: *Pelomyia occidentalis* Williston, 1893, by monotypy (as Ephydriidae)].—Becker, 1896:274 [as Ephydriidae].—Kuntze, 1897:20 [as *Tethina*].—Williston, 1908:295, 307 [as Ephydriidae and Agromyzidae].—Hendel, 1911:41 [as *Tethina* in Milichiidae]; 1917:46 [key to genera]; 1934:51 [revision, references].—Malloch, 1913:146 [as *Tethina* in Ephydriidae]; 1934:456–460 [revision, southern South American species].—Melander, 1913b:297 [as *Tethina* of authors, not Haliday, 1838]; 1952:193 [revision of Nearctic species].—Sturtevant, 1923:5–8 [discussion].—Czerny, 1928:2 [revision of Palearctic species, generic misidentification].—Séguy, 1934:397–400 [review, French fauna, generic misidentification].—Hennig, 1937:138 [Neotropical distribution].—Ardö, 1957:131 [review, North Europe, generic misidentification].—Trojan, 1962:63 [review, Poland, generic misidentification].—Stackelberg, 1970:356 [review, fauna of USSR, generic misidentification].—Foster, 1976b:1–2 [Neotropical catalog].—Hardy and Delfinado, 1980:375 [revision of Hawaiian species].—Vockeroth, 1987:1075 [key].—Mathis and Sasakawa, 1989:667 [Australasian/Oceanian catalog].—Mathis and Munari, 1996:9–10 [key and world catalog].

DIAGNOSIS.—*Pelomyia* is distinguished from other genera of the family by the following combination of characters.

Head: Slightly higher or as high as long; gena 0.08–0.50 times eye height and usually bearing scattered, minute setulae over entire surface; peristomal margin with shiny chitinous stripe; labellum short; eye round; fronto-orbital setae 1–3; parafrenal setae minute to absent; only 1 pair of ocellar seta, usually moderately strong; paravertical setae reduced and convergent; oral vibrissae usually minute, weak; true peristomal setae absent; antenna semiporrect.

Thorax: Usually with gray to brownish microtomentum; dorsocentral setae 4 (1+3); acrostichal setulae minute, in 2–4 uneven rows; disk of scutellum bare. Wing with crossvein *bmcu* usually absent. Fore- and hindfemora slightly to moderately swollen; forefemur in both sexes usually bearing anteroventral ctenidial comb of setae, comb strong in some species, weakly to moderately developed in others, rarely absent; forefemur bearing distinct row of setae on posteroventral and postero-dorsal surfaces, apical 3 or 4 setae usually strongest; midtibia bearing strong apicoventral seta; other legs evenly setulose; legs usually evenly microtomentose, although shiny or subshiny in a few species.

Abdomen: Usually with gray to brownish microtomentum, often pale gray laterally. Male terminalia: epandrium with ventrolateral processes, bifurcate in some species, widely spatulate to pointed in others, often bearing strong setae or setulae on inner or outer surface or both; true surstylus typically straight, positioned along posterior margin of epandrium, lateral of cerci, sometimes weakly articulated with epandrium, always strongly articulated with subepandrial sclerite; armature of surstylus varying from stout, peg-like setae to weak setulae; subepandrial sclerite sometimes reduced to 2 thin sclerites in parallel formation, sometimes X- or H-shaped (Figure 4) or square- or rectangular-shaped, articulated with hypandrium anteriorly and with surstylus posteriorly; cercus usually about ½ length of surstylus, pubescent, bearing many long fine setae, apical seta longest; hypandrium rather large, semicircu-

lar, with arms widely separated posteriorly where articulated with subepandrial sclerite and epandrium, anteriorly arms strongly fused with aedeagal apodeme; hypandrial apodeme absent; a tent-like hood, apparently arising from pregonites, sometimes extending dorsally over basiphallus. Internal copulatory apparatus: basiphallus oblong, ovoid, or tapered posteriorly to point, typically smooth, broadly articulated with posterior apex of aedeagal apodeme; center of basiphallus with opening for ejaculatory duct to pass through to aedeagus; most species with pair of pregonites fused to the hypandrial arms anteriorly and extended posteriorly as pair of spatulate or pointed processes usually with short setae, some species with pregonites completely fused to the hypandrium and with only the setae remaining; distinct pregonites, when present, either unfused or fused to various degrees with the postgonites; postgonites long, pointed, or spatulate posteriorly, often with centrally located scaly or nodulate flexion point; capable of 90° or more flexion; postgonites articulating with aedeagal apodeme just posterior to fusion point of hypandrium with aedeagal apodeme; aedeagal apodeme usually long, rod-like; ejaculatory apodeme moderately to widely flared; distiphallus usually long, either thick, with dense long pubescence along entire length on dorsal surface, or thin and ribbon-like, with finer pubescence; distiphallus rarely short, blunt, and relatively bare; a pair of setulose lateral lobes near apex in some species, usually long and tapered toward apex; a pair of large basal lobes sometimes present (Figure 2). Female terminalia: cercus in some species bearing thick, blunt spine-like setae, termed pseudacanthophorites by Freidberg and Beschovski (1996) in *Tethina*; spermathecae longer than wide, barrel-shaped. (A detailed study of the female terminalia was not undertaken in this study because the differences between species are relatively minor other than the presence or absence of thickened, blunt spine-like setae. Most females can be distinguished by external characters, such as genal height and coloration of legs and thorax.)

DISCUSSION.—Two synapomorphies establish the monophyly of *Pelomyia*: (1) the unique structure of the postgonites; and (2) hypandrium narrow in lateral view. Most other postabdominal characters of *Pelomyia* are probably plesiomorphic.

FIGURES 1–7 (opposite).—Structures of male terminalia: 1, internal copulatory apparatus (aedeagal apodeme, postgonite, basiphallus, gonopodal hood, pregonite, hypandrium) of *Pelomyia coronata* (Loew), lateral aspect; 2, internal copulatory apparatus of *P. coronata* (ejaculatory duct, basiphallus, basiphallal lobe, distiphallus) with pregonites and hypandrium removed, lateral aspect; 3, pregonite and postgonite complex (postgonite, nodulate flexion point, point of fusion of postgonite and pregonite, distal portion of postgonite, pregonite) of *P. coronata*, lateral aspect; 4, subepandrial sclerite of *P. coronata*, ventral aspect; 5, pregonite and pregonite hood of *P. nubila* Melander (postgonite removed), lateral aspect; 6, same, anterior aspect; 7, pregonite and postgonite complex of *P. peruviana* Malloch (postgonite, lobe of postgonite, pregonite, distal portion of pregonite), ventral aspect. Scale bars = 0.1 mm (scale bar below Figure 1 is for Figures 1–6; scale bar above Figure 7 applies only to that figure).

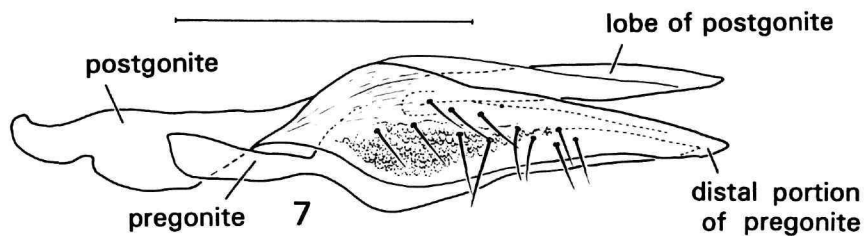
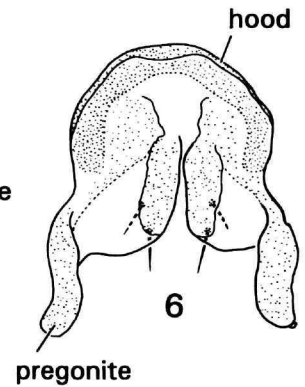
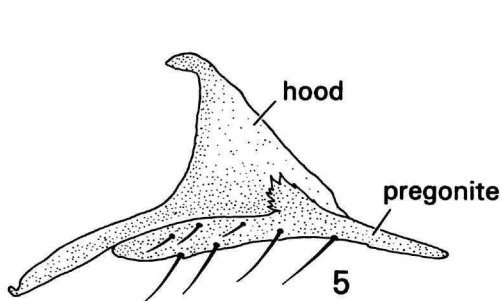
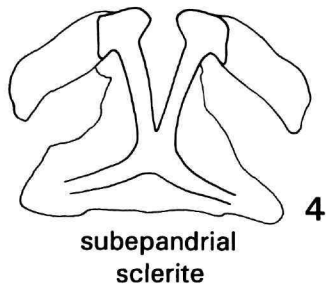
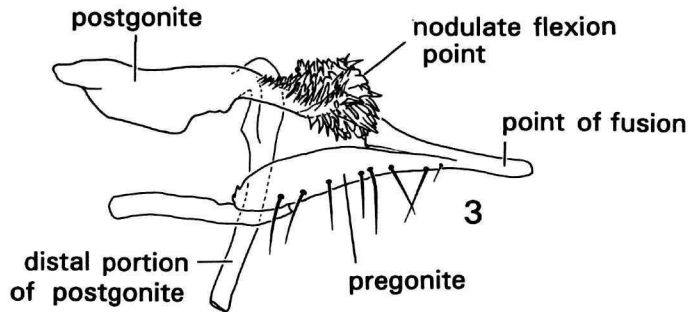
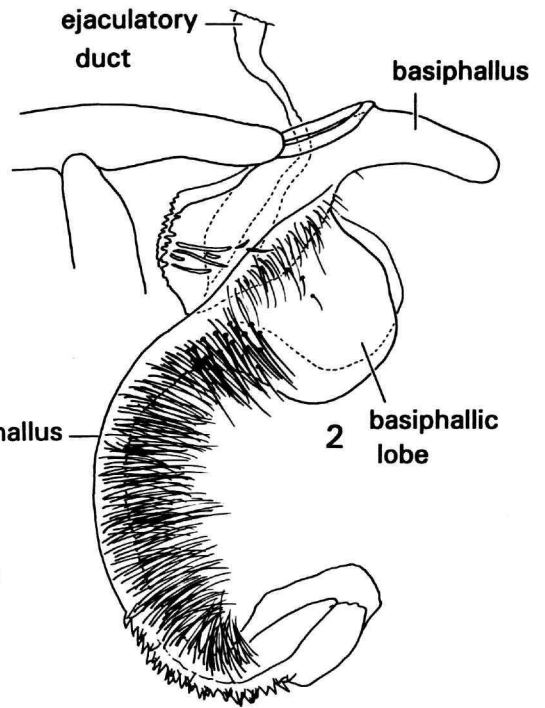
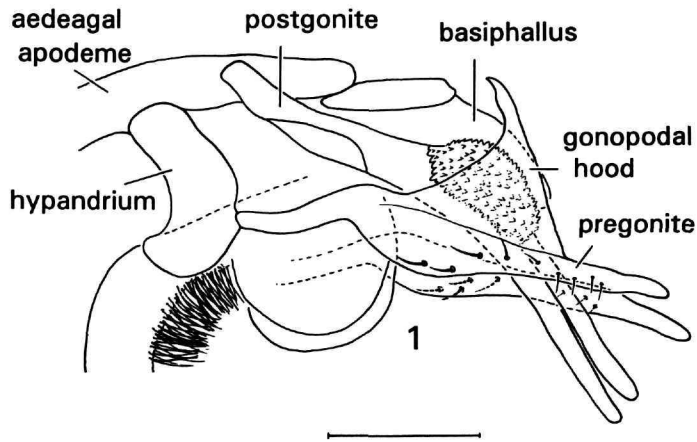

NOTES ON THE FUNCTION OF POSTGONITES.—A possible function of the postgonites in copulation may be to hold the entire apparatus outside the body so that the male does not have to use the muscles to do so. In one specimen, the postgonites bent around the posterior margin of the last abdominal segment and prevented the copulatory apparatus from sliding back into

the body. Perhaps this explains why many specimens have the postgonites bent back more than 90°. The postgonites in many species of *Pelomyia* are quite large. It is interesting that most species also have a rather large, setulose aedeagus as well. Perhaps the enlarged aedeagus requires the support of the postgonites outside of the body during copulation.

Key to Species Groups of *Pelomyia* Williston

| | |
|--------------------------------------|-----------------------------|
| Fronto-orbital setae 2 or more | the <i>melanocera</i> group |
| Fronto-orbital seta 1 | the <i>coronata</i> group |

The *coronata* Group

DIAGNOSIS.—Species of the *coronata* group have body lengths of 1.90–3.25 mm and are distinguished from the *melanocera* group by the following combination of characters.

Head: Higher than long; gena 0.20–0.50 times eye height, bearing scattered, minute setulae over entire surface; peristomal margin with shiny chitinous stripe; labellum short; eye round, facets becoming larger anteriorly; fronto-orbital seta 1; parafacial setae few, minute, with 1 slightly larger pair near base of antenna; 1 well-developed pair of ocellar setae, often with at least 2 or 3 additional weak setulae; true postvertical setae absent; paraverticilar setae minute, convergent; oral vibrissae usually weak, small; antenna correct.

Thorax: With gray to brown microtomentum, often with grayish or brownish band on anepisternum, postpronotum, notopleuron, and anatergum; dorsocentral setae 4 (1+3); acrostichal setulae minute, in 2 uneven rows; disk of scutellum bare. Wing lacking crossvein bm-cu. Forefemur in both sexes with anteroventral ctenidial comb varying from long and quite strong to minute, but always present; forecoxa black or white in base color with white microtomentum.

Abdomen: Typically with brownish to gray microtomentum, sometimes becoming paler laterally, extreme posterior margins of sternites sometimes yellowish. Male terminalia (Figures 1, 2, 8): epandrium with ventral processes long and varying in shape, often bearing strong setae or setulae on inner or outer surface or on both; true surstylus typically straight, positioned along posterior margin of epandrium, laterad of cercus, articulated with subepandrial sclerite; surstylus bearing many minute setulae; subepandrial sclerite strongly sclerotized in either an X- or H-shaped configuration or, rarely, a simple plate, articulated with hypandrium anteriorly and with surstylus posteriorly; cercus usually about ½ length of surstylus, pubescent, and bearing many long fine setae, apical seta longest; hypandrium rather large, semicircular, and 2-armed, with arms separate posteriorly, articulated with subepandrial sclerite and epandrium, arms fused anteriorly with aedeagal

apodeme; hypandrial apodeme absent. Internal copulatory apparatus: basiphallus long, triangular, and pointed posteriorly, articulated with posterior apex of aedeagal apodeme; opening present in center of basiphallus, allowing ejaculatory duct to pass through to aedeagus; pregonites (Figures 1–3) fused anteriorly to hypandrium, sometimes partially fused posteriorly with postgonite; postgonites long, pointed, or spatulate posteriorly, with a scaly or nodulate thickening centrally, sometimes flexed 90° or more at thickening, articulate with aedeagal apodeme just posterior to fusion point of hypandrium with aedeagal apodeme; aedeagal apodeme long, rod-like; ejaculatory apodeme moderately flared; aedeagus long, strap-like, with long, dense micropubescence along entire length on dorsal surface, usually tapered toward apex. Female terminalia: cercus bearing thick, blunt spines in some species, only fine setulae in others.

DISCUSSION.—A synapomorphy supporting the monophyly of this species group is the presence of a single pair of fronto-orbital setae. Species of the *melanocera* group have two or three pairs of fronto-orbital setae. The following additional diagnostic characters distinguish the two species groups: (1) Crossvein bm-cu is completely absent in the *coronata* group, whereas this crossvein is at least partially developed in the *melanocera* group and is often complete and well developed. (2) Males of the *melanocera* group may have strong, peg-like setae on the ventral lobe or surstylus. These structures in the *coronata* group are armed at most with weak setae or setulae. (3) The subepandrial sclerite in the *coronata* group may have an X- or H-shaped configuration and is rarely a single plate. In the *melanocera* group, the sclerite is usually a single plate. (4) The hypandrium of the *melanocera* group more closely resembles that of *Tethina* and other Tethininae in having the pregonites more fully fused with the hypandrium, bearing only a few setae in the location of the pregonites. In the *coronata* group, the hypandrium is mostly quite narrow, with well-developed and separate pregonites. Other differences are noted in the description of the *melanocera* group.

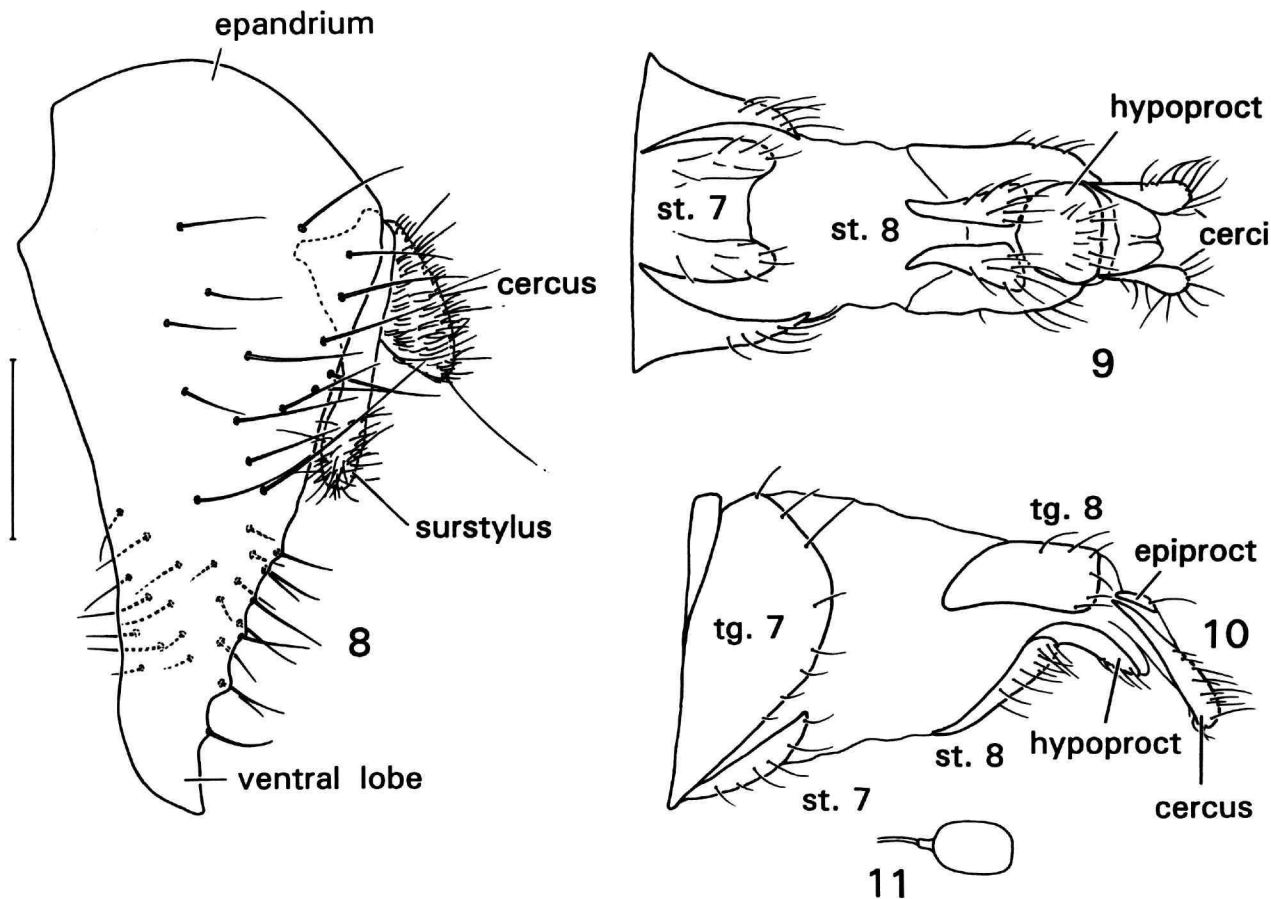

FIGURES 8-11.—*Pelomyia coronata*: 8, epandrium, cercus, and surstylus, lateral aspect; 9, female postabdomen, ventral aspect; 10, same, lateral aspect; 11, spermatheca, lateral aspect. Scale bar = 0.1 mm for Figure 8 only; scale is unknown for Figures 9-11 (pencil drawings prepared by George C. Steyskal).

Key to Males of the *coronata* Group

1. Forefemoral anteroventral ctenidial comb of setae distinctly well developed, at least as long as narrowest width of foretibia 2
 Setae of anteroventral ctenidial comb not well developed, varying but always shorter than narrowest width of foretibia 3
2. Ultimate section of vein CuA₁ longer than crossvein dm-cu 16. *P. vockerothi*, new species
 Ultimate section of vein CuA₁ equal to or shorter than crossvein dm-cu 12. *P. peruviana* Malloch
3. Forecoxa white or yellow in base color 4
 Forecoxa brown or black in base color, usually covered with whitish or silvery micro-tomentum 10
4. First and second tarsomeres of hind leg distinctly swollen 2. *P. granditarsa*, new species
 First and second tarsomeres of hind leg not distinctly swollen 5

5. Tarsi brown to black (inferred from female) 6. *P. intermedia* Malloch
 Mid- or hindtarsi with at least basal tarsomere yellow 6
6. Mesonotum uniformly brownish gray 7
 Mesonotum grayish with pale brown stripes along dorsocentral setae and at midline
 8
7. Male terminalia as in Figure 13; ventral lobe indented ventrally
 3. *P. lobina*, new species
 Male terminalia as in Figure 23; ventral lobe truncate . . . 7. *P. planibulla*, new species
8. Mid- and hindfemora yellow 4. *P. nubilata* Melander
 Mid- and hindfemora mostly or entirely black 9
9. Mid- or hindtibiae with brownish to blackish microtomentum
 5. *P. occidentalis* Williston
 Mid- or hindtibiae with at least some yellow on basal 1/2 or more
 1. *P. coronata* (Loew)
10. Antenna mostly black; at most, faintly orange on medial surface of 1st flagellomere
 11
 Antenna with at least medial surface of 1st flagellomere mostly orange 16
11. Frons dark orange to reddish brown 12
 Frons paler, yellowish orange; if darker, maxillary palpus black 13
12. Mesonotum uniformly brown or gray 17. *P. freidbergi*, new species
 Mesonotum gray with 2 brown stripes anteriorly, converging posteriorly and continu-
 ing onto scutellum; an additional stripe lateral of dorsocentral track of setae
 18. *P. curva*, new species
13. Maxillary palpus black 20. *P. nigripalpis*, new species
 Maxillary palpus yellow 14
14. Ventral lobe of epandrium truncate, not long or triangular
 22. *P. boliviensis*, new species
 Ventral lobe of epandrium long, triangular 15
15. Male genitalia as in Figure 37; surstylus long, curved anteriorly; epandrium bearing
 short, blunt setae 13. *P. robustiseta*, new species
 Male genitalia as in Figures 28, 29; surstylus shorter, club shaped, curved medially;
 epandrium bearing normal (long, evenly tapered) setae
 11. *P. nigratarsis*, new species
16. Mesonotum with one or more faint brown bands 17
 Mesonotum evenly brownish or grayish 18
17. Mesonotum entirely gray except for a single brown stripe between dorsocentral tracks
 of setae, stripe darker and wider posteriorly and continuing on scutellum
 19. *P. univittata*, new species
 Mesonotum with additional brown stripes lateral of dorsocentral tracks of setae
 14. *P. trivittata* Malloch
18. Anepisternum and anepimeron mostly brownish, contrasted sharply with grayish meso-
 notum 9. *P. aurantifrons*, new species
 Anepisternum and anepimeron with a slight tinge of brown dorsally or largely brown-
 ish, concolorous with mesonotum 19
19. Ventral lobe of epandrium rudimentary [Figures 24, 25] . . . 8. *P. dentata*, new species
 Ventral lobe of epandrium well developed 20
20. Posterior margin of ventral lobe of epandrium bearing a tuft of long, sinuous setulae
 21. *P. undulata*, new species
 Posterior margin of ventral lobe of epandrium bare 21
21. Male genitalia as in Figure 27; surstylus club shaped, longer than ventral lobe
 10. *P. irwini*, new species
 Male genitalia as in Figure 39; surstylus tapered to a point
 15. *P. viedmae* Malloch

Key to Known Females of the *coronata* Group

1. Cercus bearing stout, thick setae 2
Cercus bearing fine or strong setulae that are not thickened 3
2. Mesonotum with brown microtomentum and faint gray bands along line of dorsocentral setae and extending onto scutellum 14. *P. trivittata* Malloch
Mesonotum with evenly brownish microtomentum 15. *P. viedmae* Malloch
3. Setae of forefemoral anteroventral ctenidial comb distinctly well developed, spines at least as long as narrowest width of foretibia 4
Setae of forefemoral anteroventral ctenidial comb varying, but spines always shorter than narrowest width of foretibia 5
4. Ultimate section of vein CuA₁ longer than crossvein dm-cu
..... 16. *P. vockerothi*, new species
Ultimate section of vein CuA₁ equal to or shorter than crossvein dm-cu
..... 12. *P. peruviana* Malloch
5. Forecoxa white or yellow in base color 6
Forecoxa black or brown in base color, usually covered with whitish or silvery microtomentum 11
6. Tarsi entirely brown to black 6. *P. intermedia* Malloch
Mid- or hindtarsi with at least basal 3 tarsomeres yellowish 7
7. Mid- and hindfemora yellow 4. *P. nubila* Melander
Mid- and hindfemora mostly or entirely black 8
8. Tibiae brown to black 5. *P. occidentalis* Williston
Tibiae with at least some yellow on basal 1/3 or more 9
9. Cercus with very fine setulae only 1. *P. coronata* (Loew)
Cercus with some obviously stronger setae 10
10. Fore- and hindfemora distinctly swollen 3. *P. lobina*, new species
Fore- and hindfemora slender, narrow new species (not to be described; Chile)
11. Antenna mostly black, at most faintly orange apically on medial surface of 1st flagellomere 12
Antenna apically with 1st flagellomere extensively orange on medial surface and on at least 1/2 of lateral surface 14
12. Mesonotum gray with 2 brown stripes anteriorly, converging posteriorly and continuing onto scutellum; an additional stripe lateral of dorsocentral track of setae
..... 18. *P. curva*, new species
Mesonotum uniformly gray or brown 13
13. Frons yellow to yellowish orange 11. *P. nigratarsis*, new species
Frons dark orange to reddish brown 17. *P. freidbergi*, new species
14. Anepisternum and anepimeron mostly brown 9. *P. aurantifrons*, new species
Anepisternum only lightly brown on dorsal 1/2, anepimeron at most with slight brownish color 10. *P. irvini*, new species

1. *Pelomyia coronata* (Loew)

FIGURES 1-4, 8-12

Rhinoessa coronata Loew, 1866:185.*Tethina coronata*.—Malloch, 1913:147 [generic combination, citation].—Melander, 1913b:297 [key].*Pelomyia coronata*.—Hendel, 1917:46 [generic combination, key]; 1934:51 [key], 52 [citation].—Sturtevant, 1923:7-8 [citation, in part].—Curran 1934:330 [figure of wing].—Hennig, 1939:82 [figure of male terminalia].—Melander, 1952:193, 212 [revision, figures of male terminalia].—Vockeroth, 1965:726 [Nearctic catalog, noted to be an unworked species complex]; 1987:1076-1077 [figures of head, wing].—Cole, 1969:386 [distribution, dis-

cussion].—Foster, 1976b:1 [Neotropical catalog].—Mathis and Munari, 1996:9 [world catalog].

Pelomyia cruciata Hendel, 1934:52.—Melander, 1952:195 [citation].—Vockeroth, 1965:726 [Nearctic catalog].—Mathis and Munari, 1996:9 [world catalog]. [New Synonym.]

DIAGNOSIS.—This species is distinguished from congeners by the following combination of characters: body with brownish gray microtomentum; frons yellowish orange; parafrenal setae few, minute, 1 slightly larger seta near base of antenna; fronto-orbital seta 1, reclinate; antenna mostly brown, only distal margin and entire medial surface of first flagellomere

orange; oral vibrissae weak but distinct; gena approximately 0.30–0.35 times eye height; mesonotum with 3 faint brownish stripes along line of dorsocentral setae and on midline; dorsal $\frac{1}{2}$ of anepisternum brownish, ventral $\frac{1}{2}$ with gray microtomentum; acrostichal setulae few, minute, in 2 scattered rows; crossveins in wings not infuscate; tarsomeres of normal size (not unusually short or enlarged); forecoxa white in base color; mid- and hindfemora not swollen, evenly brown to dark gray; setae of anteroventral ctenidial comb short (shorter than width of foretibia), relatively weak, numerous.

DESCRIPTION.—Body length 1.90–3.00 mm; body generally with brown to brownish gray microtomentum.

Head: Ocellar triangle with grayish microtomentum; frons yellowish orange, extreme margins with silvery gray microtomentum; frontal lunule silvery; parafrenal setae few, minute, with 1 slightly larger near base of antenna; ocellar seta 1, strong, another 2 or 3 minute weak ocellar setulae; paravertic setae short, weak, widely separated, and convergent. Antenna mostly brown, only distal margin and entire medial surface of 1st flagellomere orange. Gena approximately 0.30–0.35 times eye height, with whitish yellow microtomentum and many minute, scattered setulae; shiny chitinous stripe along parafacial and peristomal margin; palpus yellow; clypeus brown.

Thorax: Mesonotum mostly with grayish microtomentum, with brown stripe along line of dorsocentral setae and on midline; dorsal $\frac{1}{2}$ of anepisternum with brown microtomentum and ventral $\frac{1}{2}$ with gray microtomentum, remainder of pleural surfaces mostly with gray microtomentum. Wing hyaline; costal section ratios 6.4:1.6:1.0. Forecoxa white in base color, with white microtomentum, with 2 or 3 large setae in addition to a few smaller ones; midcoxa mostly yellow, gray basally; hindcoxa gray; forefemur moderately swollen, with gray microtomentum and bearing a row of 6–8 strong setae on both postero-dorsal and posteroventral surfaces, distal 2 or 3 sometimes longest, many scattered smaller setae on remainder of posterior surface, otherwise evenly setulose; forefemoral anteroventral ctenidial comb distinct, shorter than width of foretibia; hindfemur barely swollen; mid- and hindfemora uniformly brown to dark gray, evenly setulose, with anterior surface of midfemur bearing 1 stronger seta in middle; foretibia yellowish on basal $\frac{1}{3}$, becoming gray distally; mid- and hindtibiae varying from entirely yellowish to gray on distal $\frac{1}{2}$, tibiae evenly setulose; foretarsus entirely gray, mid- and hindtarsi with basal 3 tarsomeres yellow, distal 2 tarsomeres brown.

Abdomen: With microtomentum brownish dorsally, becoming gray laterally, extreme posterior margin of each tergite yellow. Male terminalia (Figures 1–4, 8): ventral lobe of epandrium narrowed ventrally, anterior margin bare, posterior margin with several setulae; surstylus short, spatulate, with a few fine setulae; aedeagus thick, pubescent, with pair of large basal lobes; pregonites distinct, long, tapered, pointed, partly fused with postgonites distally; hypandrium in lateral view narrow; distal portion of postgonite long, tapered, pointed; basiphallus long, pointed, triangular; ejaculatory apodeme moderately

flared. Female terminalia: cercus bearing fine setulae only (Figures 9, 10); spermatheca as in Figure 11.

TYPE MATERIAL.—The holotype female of *Rhinoessa coronata* Loew is labeled “Georgia [green; handwritten]/Loew Coll./coronata m. [handwritten]/Rhinoessa [handwritten]/Type 13445 [red label; number handwritten]/Holo-type [round label with red margin]/Holotype ♀ *Rhinoessa coronata* Loew A. Irwin 1982 [handwritten].” The holotype is pinned directly, is in good condition (abdomen removed, dissected, and preserved in a microvial that is on a separate pin), and is deposited in the MCZ (13445).

The lectotype male of *Pelomyia cruciata* Hendel, herein designated to stabilize and make more universal the use of this name, is labeled “[UNITED STATES] Atherton, M[iss]o[uri]. Independence:]. IX-10-15 [10 Sep 1915]/*Pelomyia coronata* Lw. [handwritten; black submargin]/LECTO-TYPE [round label with a dark blue border]/Lecto-type [round label; handwritten; blue border]/Lectotype *Pelomyia cruciata* Hendel 1934 Det. A.G. Irwin 1982 [handwritten]/LECTOTYPE ♂ *Pelomyia cruciata* Hendel By Foster & Mathis [all except ‘LECTO-TYPE’ and ‘By’ handwritten; black submarginal border].” The lectotype male is double mounted (smaller pin with base wound around main pin), is in good condition (first flagellomeres missing, hole in part of scutellum, some setae misdirected), and is deposited in the NMW. Although Irwin studied this specimen and attached a lectotype label, the designation was never published and is thus invalid. A paralectotype female with the same locality data is herein designated.

OTHER SPECIMENS EXAMINED.—UNITED STATES. *Arizona.* Cochise: Charleston, 26 Mar 1967, D.M. Wood (1♀; CNC); Douglas, 1 May 1942, A.L. Melander (1♂; USNM). Coconino: Littlefield (ex. *Salsola pestifer*), 15 May 1932, E.W. Davis (1♂; USNM); Oak Creek, Todd’s Lodge, 7–9 May 1950, J.L. Sperry (3♀; USNM). Graham: Marijilda Canyon (0.9 mi along road from highway 666; 3860 ft), 3 Aug 1965, H.B. Leech (1♂; CAS). Maricopa: Gila Bend, 9 Apr 1947, A.L. Melander (1♂; USNM). Pima: Organ Pipe Cactus National Monument, Organ Pipe Park, Alamo Canyon, 16 Apr 1947, A.L. Melander (3♂; USNM); Organ Pipe Cactus National Monument (on *Baileya* sp.), 14 Apr 1948, A.L. Melander (1♂; USNM); Quitobaquito (Organ Pipe Cactus National Monument), 13 Apr 1948, A.L. Melander (2♂; USNM); Quitobaquito (Organ Pipe Cactus National Monument; 3 mi W), 14 Feb 1970, P.H. Arnaud, Jr. (1♀; CAS); Sabino Canyon, 27 Apr–5 May 1942, 1948, A.L. Melander (3♂, 5♀; USNM); Tucson, Saguara Monument, 10 Apr 1935, A.L. Melander (1♂; USNM). Pinal: Superior, 13 Apr 1935, A.L. Melander (4♂, 1♀; USNM). Yavapai: Congress, 23–26 Apr 1967, D.M. Wood (2♂; CNC). Yuma: Yuma (23 mi N), 2 Apr 1967, D.M. Wood (1♂; CNC). *California.* Imperial: Brawley, 7 Apr 1947, A.L. Melander (1♂; USNM); Salton Sea Beach, 12 Nov 1945, A.L. Melander (1♂; USNM); Westmoreland, 6 Apr 1949, W.W. Wirth (1♂; USNM). Inyo: Death Valley Furnace Creek, 23 Apr 1935, A.L. Melander (1♂, 1♀; USNM); Lone Pine (S edge), 17 Jun 1962, J. Tomlinson (1♀;

CAS); Panamint Valley, 12 Mar 1941, T. Aiken (8♂; USNM). Kern: Arvin, 14 Mar 1935, A.L. Melander (1♂; USNM); Roger Dry Lake, 16 Mar 1935, A.L. Melander (1♂; USNM). Los Angeles: Big Rock Wash, 12 May 1944, A.L. Melander (2♂; USNM); Claremont, 23 Jan 1935, A.L. Melander (1♀; USNM); Green Valley, 26 Jul 1944, A.L. Melander (1♂; USNM); Los Cerritos, 14 Mar 1915, M.C. VanDuzee (1♀; CAS); Mojave Desert, Lovejoy Lake, 10 May 1944, A.L. Melander (7♂, 7♀; USNM); Valyermo, 13 May 1944, A.L. Melander (2♀; USNM). Monterey: Asilomar, 4 Aug 1950, A.L. Melander (1♂; USNM); Pfeiffer, Big Sur State Park, 16 Jun 1949, P.H. Arnaud (1♂; USNM); Point Lobos, 6 Aug 1969, B. Hocking (1♀; CNC). Napa: St. Helena, 3 Jun 1909, C. Fuchs (1♂; USNM). Orange: Buena Park, 19 May–23 Dec 1944, A.L. Melander (5♂, 3♀; USNM); Capistrano Hot Springs, 29 Jun 1942, A.L. Melander (1♂; USNM); Corona del Mar, 25 Mar–29 Jun 1942, 1945, 1946, A.L. Melander (2♂, 2♀; USNM); Huntington Beach, 4 Jun 1945, A.L. Melander (1♀; USNM); Laguna, 23 Jun 1954, A.L. Melander (1♂; USNM); Laguna Beach, 22 May–18 Aug 1943, 1944, A.L. Melander (2♂, 1♀; USNM); Orange (on foliage of lima beans), 31 May 1950, H.H. Keifer (1♂; USNM); San Clemente, 23 May–18 Oct 1944, A.L. Melander (3♂, 2♀; USNM). Riverside: Agua Caliente Indian Reservation (Palm Canyon), 24–27 Feb 1970, P.H. Arnaud, Jr. (1♀; CAS); Andreas, 23 Mar 1951, A.L. Melander (1♂; USNM); Andreas Canyon, 17 Mar–22 May 1945, 1951, 1956, 1960, A.L. Melander (13♂, 4♀; USNM); Blythe, 1 May 1955, W.R. Richards (2♂, 1♀; CNC); Cabazon, 31 Mar 1945, A.L. Melander (1♂; USNM); Cottonwood Spring, 7 Apr 1949, W.W. Wirth (1♂; USNM); Elnore Lake, 25 Jan 1935, A.L. Melander (1♂; USNM); Hemet Lake (4500 ft), 13 Apr 1961, J.G. Chillcott (11♂, 5♀; CNC); Herkey Creek Camp, 14 May 1950, A.L. Melander (1♀; USNM); Hunter's Spring, 10 May 1952 (2♂; USNM); Indio, 6 Mar–2 May 1945, 1949, 1955, W.R.M. Mason, A.L. Melander, W.R. Richards, R.E. Ryckman (14♂, 2♀; CNC, USNM); Joshua Tree National Monument, Live Oak Tank, 22 Apr 1944, A.L. Melander (1♀; USNM); Keen Camp, 7 Jun 1942, A.L. Melander (4♂; USNM); La Quinta, 19 Mar–13 Apr 1958, 1962, J.G. Chillcott, A.L. Melander (33♂, 10♀; CNC, USNM); Ortega Highway, Mariana River, 19 Oct 1944, A.L. Melander (1♀; USNM); Ortega Highway, San Juan Camp, 26 May 1944, A.L. Melander (1♀; USNM); Palm Canyon, 27 Feb–7 Nov 1934, 1935, 1955, A.L. Melander, W.R. Richards (4♂, 4♀; CNC, USNM); Palm Desert (2000 ft), 4 Apr 1955, W.R. Richards (1♂, 1♀; CNC); Palm Springs, 26 Feb–20 Nov 1935, 1943, W.R.M. Mason, A.L. Melander (20♂, 11♀; USNM); Palm Springs (5 mi W), 6 Apr 1949, A.L. Melander (1♂; USNM); Palm Springs, Smoke Tree Ranch, 6 Apr 1949, A.L. Melander (1♂; USNM); Rancho Mirage, 6 Apr 1955, W.R.M. Mason (6♂; CNC); Riverside, 6 Jan–22 Dec 1935, 1940, 1942, 1944, 1950, A.L. Melander (31♂, 36♀; USNM); Temecula, 7–27 Jun 1945, 1950, A.L. Melander (2♂, 1♀; USNM); Thermal, 14 Mar–9 Apr 1955, W.R. Richards (6♂, 4♀; CNC); Thousand Palms, 22 Mar–5 Apr 1955, J.E.H. Martin, W.R. Richards (18♂, 11♀; CNC); Thousand Palms, Thousand Palms Oasis, 10 Mar–25 Apr 1955, W.R.M. Mason (16♂, 5♀; CNC); Thousand Palms, Willis Palms Oasis, 18 Mar 1955, W.R.M. Mason (3♂, 1♀; CNC); White Water, 16 Mar–16 May 1954, 1955, A.L. Melander, W.R. Richards (2♂, 3♀; CNC, USNM); White Water, Snow Creek (1500 ft), 16 Mar 1955, W.R. Richards (1♂, 1♀; CNC); White Water Canyon, 11 Nov 1944, A.L. Melander (2♂; USNM). San Bernardino: Apple Valley, 7–8 May 1955, W.R. Richards (1♂, 1♀; CNC); Arrowhead Springs, 24 May 1935, A.L. Melander (1♀; USNM); Baker (14 mi S), 23–24 Apr 1969, R.R. Pinger (1♂; USNM); Barton Flat, South Fork Camp, 2 Sep 1944, A.L. Melander (1♀; USNM); Big Bear Lake, 6 Jul 1942, A.L. Melander (3♂, 1♀; USNM); Cajon, 9 Aug 1944, A.L. Melander (1♂, 1♀; USNM); Camp Angelus, 28 May–2 Jun 1947, A.L. Melander (1♂, 1♀; USNM); Crestline, 4 Jul 1942, A.L. Melander (1♂; USNM); Helendale, 18 May 1955, W.R. Richards (5♂, 3♀; CNC); Jenks Lake, 7 Jun 1956, A.L. Melander (1♀; USNM); Mentone, 13 May 1947, A.L. Melander (2♂; USNM); Mountain Home, 24 Aug–24 Sep 1944, A.L. Melander (1♂, 1♀; USNM); Morongo, 26 Sep 1944, A.L. Melander (1♂; USNM); Morongo Inn, 10 May 1935, A.L. Melander (1♀; USNM); Morongo Valley, 19–22 Apr 1944, A.L. Melander (2♂, 1♀; USNM); Oak Glen, 7 Jul–19 Sep 1945, 1946, A.L. Melander (2♂; USNM); Phelas, Sheep Creek Canyon, 9 May 1949, A.L. Melander (1♂; USNM); Piute Butte (Mojave Desert), 12 May 1944, A.L. Melander (2♀; USNM); Quail Spring (Joshua Tree National Monument), 5 Oct 1934, A.L. Melander (3♂, 3♀; USNM); Redlands, 1913, F.R. Cole (1♂; USNM); San Bernardino Mountains, South Forks Meadows, 1 Jun 1947, A.L. Melander (1♂; USNM); Sheep Creek Canyon, 1 May 1946, A.L. Melander (1♂; USNM); Scotland, 19 Sep 1943, A.L. Melander (7♂, 1♀; USNM); South Fork Santa Ana River, 14 Jun–2 Aug 1942, 1945, 1954, A.L. Melander (4♂, 1♀; USNM); Stoddard Well, 30 May 1944, A.L. Melander (1♂, 1♀; USNM); Thorn, 30 May 1944, A.L. Melander (2♂; USNM); Twenty-nine Palms, 5 Sep 1946, A.L. Melander (1♂; USNM); Upper Santa Ana River, 28 Apr–25 Aug 1947, 1950, 1955, 1956, 1958, 1959, A.L. Melander (7♂, 3♀; USNM); Verdemont, 28 Jun 1945, A.L. Melander (1♂; USNM); Victorville, 12–30 May 1944, 1955, W.R.M. Mason, A.L. Melander, W.R. Richards (4♂, 3♀; CNC, USNM); Yucca Valley, 5 Oct 1934, A.L. Melander (1♂; USNM). San Diego: Agua Caliente, 5 Apr 1967, D.M. Wood (1♀; CNC); Borrego, 5 Apr–5 May 1946, 1949, J.L. Sperry, W.W. Wirth (2♂; USNM); Cuyamaca Lake (4600 ft), 21 Apr 1955, W.R. Richards (1♂; CNC); Cuyamaca Park, 6 May 1945, A.L. Melander (2♂, 1♀; USNM); La Jolla, 1 Jan–29 Dec 1934, 1935, A.L. Melander (2♀; USNM); Lake Henshaw, 7 May 1945, A.L. Melander (1♂; USNM); Oak Grove, 8–9 May to 4 Nov 1945, A.L. Melander (5♂, 1♀; USNM); San Diego, 3 Apr–30 Dec 1916, 1934, H.G. Dyer, A.L. Melander (3♂, 1♀; USNM). San Francisco: San Francisco, 17 May 1952, C.E. Kaufeldt (1♀; CAS). San Luis Obispo: Soda Lake (S end; 15

mi SE Simmler), 2 Apr 1969, H.B. Leech (1♀; CAS). Santa Barbara: Carpinteria, 8 Oct 1946, A.L. Melander (1♀; USNM). Santa Clara: Stanford, Jul 1915, A.L. Melander (3♂, 6♀; USNM). Santa Cruz: Santa Cruz, 9 Aug 1950, A.L. Melander (1♂; USNM). Sonoma: Bodega Marine Station, 3 May 1968, D.D. Munroe (1♀; CNC). Sutter: Live Oak Park, 6–7 Jun 1945, A.L. Melander (1♂, 2♀; USNM). *Colorado*. Archuleta: Pagosa Springs (hot springs), 27 May 1969, W.W. Wirth (1♀; USNM). Boulder: Boulder, Boulder Res. (5000 ft), 30 May 1961, B.H. Poole (1♀; CNC). Clear Creek: Loveland Pass (W slope; 9850 ft), 28 Jul 1961, B.H. Poole (1♂, 1♀; CNC). Eagle: State Bridge near Bond (7000 ft; dry river bed and bank), 24–25 Jun 1961, C.H. Mann (1♀; CNC). El Paso: Manitou Springs, 18 Jun 1940, A.L. Melander (3♂, 1♀; USNM). Park: Hartsel, 20 Jun 1940, A.L. Melander (1♂; USNM). *Florida*. Hillsborough: St. Petersburg, 28 Mar 1932, A.L. Melander (1♀; USNM). Marion: Silver Springs, 2 Apr 1932, A.L. Melander (1♂; USNM). *Idaho*. Bannock: Lava Hot Springs, 14 Jul 1988, W.N. and D. Mathis (1♂; USNM). Latah: Kendrick, 7 Jun 1917 (1♂; USNM). Nez Perce: Lewiston, 26 Jun 1921, A.L. Melander (1♂; USNM); Lewiston Hill, 31 May 1924, A.L. Melander (2♂; USNM). *Nevada*. Clark: Las Vegas, 15 Apr 1932, H.W. Davis (2♂; USNM); Overton, 3 Nov 1929, D. Fox (1♂; USNM); Las Vegas Springs (36°10.4'N, 115°11'W), 11 May 2001, D. and W.N. Mathis (12♂; USNM); Las Vegas Wash (35°05.2'N, 114°58.8'W), 10–11 May 2001, D. and W.N. Mathis (19♂, 7♀; USNM); Red Rock Canyon (Calico Basin, Red Spring; 36°08.7'N, 115°25'W), 11 May 2001, D. and W.N. Mathis (17♂, 1♀; USNM). Humboldt: Golconda Summit (E foot; 0.5 mi N highway 40; 4800 ft), 26 Aug 1965, H.B. Leech (2♀; CAS). Lincoln: Crystal Springs, 21 Jun 1953, A.B. Gurney (1♂; USNM). Nye: Ash Meadows National Wildlife Refuge (Crystal Spring; 36°25.2'N, 116°19.8'W), 12 May 2001, D. and W.N. Mathis (9♂; USNM); Ash Meadows National Wildlife Refuge (Peterson Reservoir; 36°26.7'N, 116°21'W), 12 May 2001, D. and W.N. Mathis (7♂, 1♀; USNM). *New Mexico*. Catron: Gila National Forest, Middle Fork Gila River (riparian zone), 29 May 1991, B.J. Sinclair (2♂; CNC); Glenwood (5 mi E), 24 Jun 1953, W.W. Wirth (1♂; USNM). Colfax: Cimarron (river margin), 26 May 1969, W.W. Wirth (1♂; USNM). Dona Ana: Mesilla Park, 5 May 1909, C.N. Ainslie (2♂; USNM). Otero: High Rolls, 29 May 1902 (1♂; USNM); Cloudcroft, 26 May 1964, J.F. McAlpine (3♂, 3♀; CNC). *New York*. Schoharie: Sharon Springs, 26 Jun 1934, A.L. Melander (2♀; USNM). *Texas*. Brewster: Big Bend National Park, Dugout Wells (3000 ft), 13–22 May 1959, J.F. McAlpine (15♂, 9♀; CNC). Galveston: Galveston, Jun 1900 (1♂; USNM). Jeff Davis: Fort Davis (Limpia Canyon; 5000 ft), 27 Apr–28 May 1959, E. Becker, H. Howden, W.R.M. Mason (2♂; CNC); Toyavale, 22 Mar 1967, D.M. Wood (1♀; CNC). *Utah*. Garfield: Alvey Wash (8.4 km S Escalante; 37°42.3'N, 111°37.6'W; 1880 m), 21 May 2001, D. and W.N. Mathis (3♂; USNM); Deer Creek (37°51.2'N, 111°21.1'W; 1762 m), 21 May 2001, D. and W.N. Mathis (1♂; USNM); Willow Tank,

Hurricane Wash (37°23.2'N, 111°08'W), 22 May 2001, D. and W.N. Mathis (2♂; USNM); 40-Mile Spring/Tank (69 km SE Escalante; 37°21'N, 111°4.9'W), 22 May 2001, D. and W.N. Mathis (3♂; USNM). Kane: Coral Pink Sand Dunes (Moquith Mountain Wilderness; 37°04.6'N, 112°40.7'W), 16 May 2001, D. and W.N. Mathis (1♂; USNM); Coral Pink Sand Dunes (Sand Spring; 37°04.6'N, 112°39.9'W), 16 May 2001, D. and W.N. Mathis (3♂; USNM); Coral Pink Sand Dunes (Water Canyon; 37°3'N, 112°40'W), 16 May 2001, D. and W.N. Mathis (1♂; USNM); Drip Tank Canyon (37°19.4'N, 111°31.8'W), 15 May 2001, D. and W.N. Mathis (5♂; USNM); East Fork of Virgin River (26.6 km N Knab; 37°12.2'N, 112°41.4'W), 18 May 2001, D. and W.N. Mathis (1♂; USNM); Kanab, 19 Apr 1935, A.L. Melander (1♂, 1♀; USNM); Kanab (6.5 km N; 37°08.7'N, 112°32.4'W), 14 May 2001, D. and W.N. Mathis (3♂; USNM); Kanab (East Fork Virgin River; 26.6 km N; 37°12.2'N, 112°41.4'W), 18 May 2001, D. and W.N. Mathis (3♂; USNM); Kanab (Seaman Wash and Spring; 24.5 km E; 37°07'N, 112°15'W), 14 May 2001, D. and W.N. Mathis (2♂, 1♀; USNM); Kanab (Sheep Creek; 37°29.7'N, 112°04'W), 17 May 2001, D. and W.N. Mathis (2♂; USNM); White House Spring (71 km E Knab; 37°04.8'N, 111°53.4'W; 1250 m), 19 May 2001, D. and W.N. Mathis (4♂; USNM). Sanpete: Moroni, 27 Jun 1940, A.L. Melander (1♀; USNM). Sevier: Richfield (beet collection; light trap), 28 May–21 Sep 1929, 1930, D. Fox (5♂; USNM). Utah: Spanish Fork, D.E. Hardy (2♂; USNM). Washington: St. George (sugar beet seed), 20 Nov 1936, E.W. Davis (1♂; USNM); Santa Clara (ex. *Sal-sola pestifer*), 17 Sep 1929, D. Fox (2♂; USNM); Zion National Park, 20 Apr 1935, A.L. Melander (3♂; USNM). *Washington*. Benton: Kennewick, 22 May 1917, A.L. Melander (1♂; USNM). Chelan: Lake Chelan, Stehekin, 30 Jul 1919, A.L. Melander (1♂; USNM); Wenatchee, 4 May–8 Jun 1919, A.L. Melander (2♀; USNM). Klickitat: Glenwood Road, Klickitat River, 23 Jul 1921, A.L. Melander (3♂, 1♀; USNM); Husum, 28 Jun–26 Jul 1917, 1921, A.L. Melander (1♂, 1♀; USNM). Spokane: Austin, 19 May 1923, A.L. Melander (1♂; USNM). Whitman: Almota, 2 Jun 1918, A.L. Melander (1♂; USNM). Yakima: Hoover, 17 Jul 1921, A.L. Melander (1♂, 1♀ (in copula); USNM).

CANADA. *Alberta*: Lethbridge, 5 Jul 1956, O. Pech (1♀; CNC). *British Columbia*: Osoyoos, 8 May 1953, J.R. McGillis (1♂; CNC); Summerland, 15 Sep 1930, A.A. Dennys (1♀; CNC). *Saskatchewan*: Buffalo Pound Provincial Park (ex. *Kochia* sp.), 6 Aug 1980, M.G. Maw (1♂; CNC); Dilke, 6 Aug 1980 (ex. *Artemisia absinthium*), M.G. Maw (1♀; CNC); Grenfell, 9 Jul 1980 (ex. *Tanacetum vulgare*), M.G. Maw (1♂; USNM); Red Deer Hill, 22 Jul 1980 (ex. *Cirsium arvense* and *Sonchus arvensis*), R. Lere (2♂, 1♀; CNC); Weyburn (ex. *Sal-sola pestifer*), 10 Jul 1980, C. Nichols (1♀; CNC).

MEXICO. *Baja California Norte*: Arroyo del Rosario (3 mi above El Rosario), 26 Apr 1963, P.H. Arnaud, Jr., H.B. Leech (2♂; CAS); La Grulla (Sierra San Pedro Martir; 6900 ft), 12 Jun 1953, P.H. Arnaud, Jr. (2♂, 6♀; CAS); Rancho Viejo

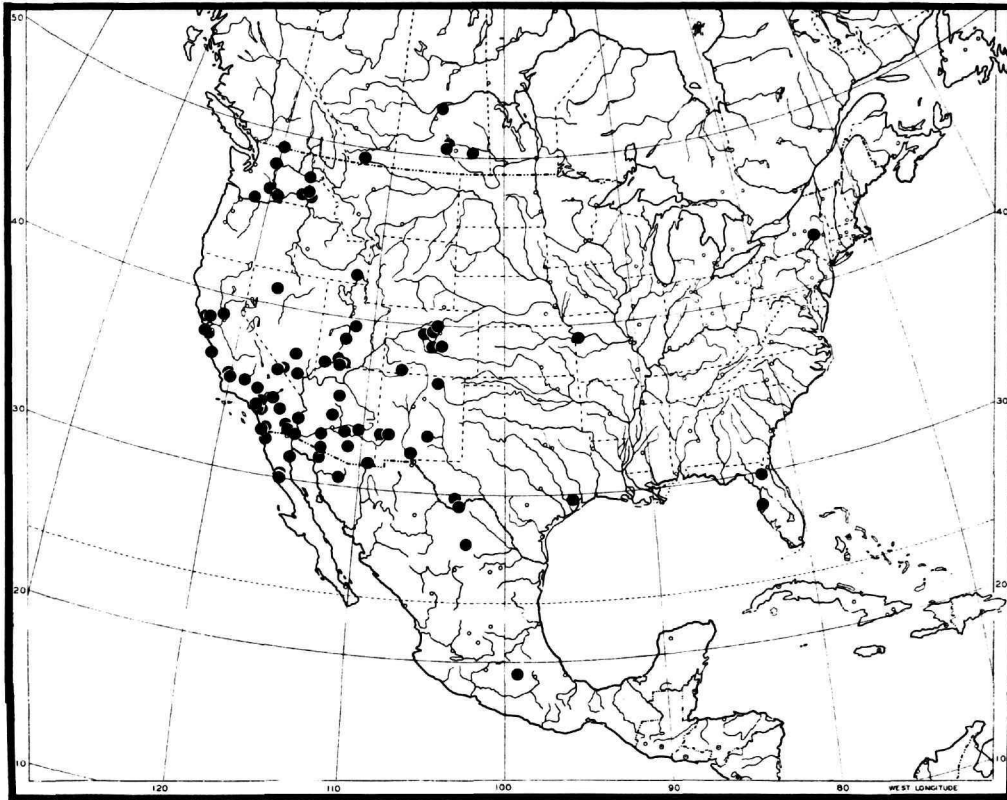

FIGURE 12.—Distribution map for *Pelomyia coronata*.

(Sierra San Pedro Martir; 7000 ft), 13 Jun 1953, P.H. Arnaud, Jr. (2♀; CAS); Rio Guadalupe (carretera 3), 29 Apr 1963 (1♂; CAS); San Carlos (Agua Caliente; 18.5 km E Maneadero), 6 Jul 1973, P.H. Arnaud, Jr. (13♂, 21♀; CAS); Santo Domingo (5.7 mi E Hamilton Ranch; damsite), 22–25 Apr 1963, P.H. Arnaud, Jr., H.B. Leech (32♂, 66♀; CAS); Tijuana (45 km S), 26 Jun 1950, A.L. Melander (3♂, 8♀; USNM); Tijuana (60 mi S), 26 Jun 1950, A.L. Melander (1♂, 1♀; USNM). *Chihuahua*: Camargo, 30 May 1964, J.F. McAlpine (1♂; CNC). *Distrito Federal*: Contreras, 6 Aug 1965, N.H.L. Krauss (1♂; USNM). *Puebla*: Lake Alchichica (2400 m; near San José Alchichica), 24 Feb 1998, A. Freidberg (2♂, 13♀; USNM). *Sonora*: Rocky Point Marsh, 21 Apr 1947, A.L. Melander (2♀; USNM); Sonoyta, 21 Apr 1947, A.L. Melander (1♀; USNM).

DISTRIBUTION (Figure 12).—Nearctic: Canada (AL, BC, SK), United States (AZ, CA, CO, FL, ID, MO, NV, NM, NY, TX, UT, WA). Neotropical: Mexico (BCN, CHI, DF, PUE, SON).

VARIATION.—Some variation was noted in the coloration of the legs, particularly the tibiae. Some specimens exhibit entirely yellow mid- and hindtibiae, whereas in others the distal half is pale to dark gray. The holotype of *R. coronata* has partially yellowish tibiae.

There is also slight variation in the shape of the ventral process of the epandrium in *P. coronata*. In some specimens the process is narrower distally and may exhibit a slightly greater posterior curvature and relatively more sharpness at the apex.

SIMILAR SPECIES.—The lateral aspect of the thorax in *P. coronata* is mostly gray with some pale brownish coloration along the dorsal half of the anepisternum. In *P. occidentalis*, the mesonotal pleurites show a broad, darker brown stripe along the postpronotal, notopleural, and anatergal surfaces. *Pelomyia occidentalis* generally has a darker appearance than *P. coronata*.

REMARKS.—Loew described *P. coronata* from a female specimen and apparently studied no males. Hendel (1934) provided a key to the species of *Pelomyia* that included only two, *P. coronata* and his new species, *P. cruciata*. Hendel distinguished *P. cruciata* by structures of the male terminalia: “styli” (ventral lobe of the epandrium) pointed, crossed, and not forked. Hendel wrote that the male “styli” of *P. coronata* are not tapered and pointed but are wide and bifurcate with a rounded area between the two branches. It is uncertain how Hendel determined that the specimens before him were Loew’s *P. coronata*. Additionally, he did not record data for specimens, if any, that he examined.

Melander (1952:194) also noted that Hendel "erected his species *P. cruciata* on specimens having slender, acutely pointed and crossed claspers." Concerning *P. cruciata*, Melander further noted that "the slender valve [of] the single apex is narrowly acute. This is the form most commonly encountered and agrees with Hendel's description of *P. cruciata*."

The specimens Hendel examined have a straight ventral lobe and were named *P. cruciata*. Melander (1952) recognized *P. cruciata* and the form of its epandrium; however, on the basis of various color differences and placement of frontal setae, he believed that some *P. coronata* had an identical epandrium to *P. cruciata*.

Melander (1913b) first synonymized *P. occidentalis* with *P. coronata* in his key to species of *Tethina*. The key indicates that *P. coronata* has one large fronto-orbital seta and that the forecoxa is microtomentose and white. (The other key couplet is for two small fronto-orbital setae, and this goes to *T. parvula* and *T. maritima*, n. sp.) He recorded this species from Georgia, Louisiana, California, Washington, and Alabama. It is noteworthy, however, that Melander did not examine any type material to justify his synonymy.

Although Sturtevant (1923), who studied the types of both species, confirmed Melander's (1913b) synonymy of *P. occidentalis* with *P. coronata*, he did not examine the structures of the male terminalia. Thus, his acceptance of Melander's synonymy must be considered provisional. We now know from detailed studies of these structures that Melander and Sturtevant's synonymy was incorrect.

Sturtevant (1923) also wrote that he had studied specimens of *P. coronata* from Peru. We have not examined any specimens of this species or of *P. occidentalis* from south of Mexico and suggest it likely that Sturtevant misidentified *P. intermedia*, *P. irwini*, or *P. aurantifrons* as *P. coronata*. These three species occur in Peru, are similar in appearance, and are fairly closely related to *P. coronata* and *P. occidentalis*.

We examined the single male and female syntypes of *P. cruciata* and confirm that they are conspecific with *P. coronata*. The postabdominal structures of the male, designated above as the lectotype, are well exposed and did not require dissection. A.G. Irwin had dissected the female's abdomen, and the abdominal structures agree well with those of other females of *P. coronata*.

2. *Pelomyia granditarsa*, new species

FIGURE 16

DIAGNOSIS.—This species is distinguished from congeners by the following combination of characters: body with brown microtomentum; frons orange with a few minute setulae; parafacial setae minute, scattered; fronto-orbital setae 2, reclinate; antenna mostly brown, medial surface of pedicel and 1st flagellomere yellow; oral vibrissae weak; gena 0.5 times eye height; acrostichal setulae minute, scattered; wing crossveins not infuscate; 1st and 2nd tarsomeres of hind leg distinctly swollen;

forecoxa white in base color; mid- and hindfemora not swollen; forefemoral anteroventral ctenidial comb of setae apparently absent.

DESCRIPTION.—Body length 3.30 mm; body with brown microtomentum.

Head: Ocellar triangle with gray microtomentum; frons orange, parafrons with silvery gray microtomentum; frontal lunule white; parafacial setae few, minute; ocellar setae 1 pair, strong, additional pair of weak ocellar setulae; paravertic setae minute, convergent. Antenna mostly brown, medial surface of pedicel and 1st flagellomere yellow. Gena 0.50 times eye height, with yellow microtomentum and bearing a few weak setulae on peristomal margin; face wider than that of other *Pelomyia* and with a raised, medial, vertical carina; shiny chitinous stripe along parafacial and peristomal margins; palpus yellow; clypeus with brown microtomentum.

Thorax: Mesonotum generally with brown microtomentum. Wing hyaline; costal section ratios 5.7:1.4:1.0. Forecoxa white in base color, with whitish microtomentum, with 2 or 3 large setae in addition to a few smaller ones; mid- and hindcoxae with yellow microtomentum; forefemur moderately swollen, mostly with yellow microtomentum and bearing a row of 6–8 strong setae on both posterodorsal and posteroventral surfaces, distal 2 or 3 strongest, many scattered smaller setae on remainder of posterior surface, otherwise evenly setulose; forefemoral anteroventral ctenidial comb of setae apparently absent; hindfemur moderately swollen; mid- and hindfemora mostly with yellow microtomentum, evenly setulose, anterior surface of midfemur with 1 stronger seta in middle; tibiae yellow, microtomentose, evenly setulose; tarsi brown, basal 2 tarsomeres of hind leg distinctly swollen, with 1st tarsomere at least 3× longer and wider than 2nd.

Abdomen: With uniformly brown microtomentum. Male terminalia unknown.

TYPE MATERIAL.—The holotype male, the only known specimen of this species, is labeled "B-15 1932/Las Vegas, Nev Apr. 15, 1932 E. W. Davis/Lepidium fremonti [Brassicaceae]/2017A/HOLOTYPE *Pelomyia granditarsa* ♂ Foster & W.N. Mathis USNM [red label; species name and '♂ Foster &' handwritten]." The holotype is double mounted (glued to a paper triangle), is in poor condition (mostly greasy and partially covered with the mounting glue; we cannot dissect the specimen without destroying it), and is deposited in the USNM.

DISTRIBUTION (Figure 16).—Nearctic: United States (NV).

ETYMOLOGY.—The species epithet, *granditarsa*, is of Latin derivation and alludes to the enlarged tarsi of this species.

REMARKS.—This species, compared with other species of *Pelomyia*, is unusual in a number of features. The head is as high as long, almost square in lateral view; the face and frons are much wider than that of other species of the genus; and there are no setulae on the gena except on the peristomal margin. In some respects this species resembles species of *Tethina*. The tarsal structure is unique for the entire family. The male

postabdomen will remain unknown until more specimens are available.

If being morphologically distinct was the only criterion for recognition of a new genus, this species would perhaps qualify for generic status. Regardless of criteria, we are hesitant to describe a new genus given the poor condition of the only known specimen.

3. *Pelomyia lobina*, new species

FIGURES 13, 16

DIAGNOSIS.—This species is distinguished from congeners by the following combination of characters: body uniformly with pale gray microtomentum, dorsal ½ of anepisternum pale brown to brown; frons yellow; parafrons with silvery gray to yellowish microtomentum; parafrontal setae present as minute hairs, 1 pair near base of antenna slightly larger; fronto-orbital seta 1, reclinate; antenna mostly brown with 1st flagellomere mostly orange, only area around base of arista brown; oral vibrissae weak, minute; gena variable, 0.20–0.40 times eye height; acrostichal setulae minute, in 2 uneven rows; wing crossveins not infuscate; tarsomeres of normal size; forecoxa white; mid- and hindfemora somewhat swollen, gray; forefemoral anteroventral ctenidial comb of setae minute, of uneven lengths, shorter than width of foretibia.

DESCRIPTION.—Body length 1.90–2.45 mm; body uniformly with pale gray microtomentum, dorsal ½ of anepisternum pale brown to brown.

Head: Ocellar triangle with silvery gray microtomentum; frons yellow, parafrons with silvery gray to yellowish micro-

mentum; frontal lunule silvery; parafrontal setae few, minute, anterior pair slightly larger than the others; ocellar setae 1 pair, strong, additional 2 or 3 minute, weak ocellar setulae; paravertic setae minute, widely separated and convergent. Antenna mostly brown with 1st flagellomere mostly orange, with only area around base of arista mostly brown. Gena 0.20–0.40 times eye height, with white microtomentum, bearing many minute, scattered setulae; shiny chitinous stripe along parafacial and peristomal margins; palpus yellow; clypeus with brown microtomentum.

Thorax: Mesonotum uniformly with gray microtomentum, dorsal ½ of anepisternum brownish. Wing hyaline; costal section ratios 7.0:1.75:1.0. Forecoxa white in base color, with whitish microtomentum, with 2 or 3 large setae in addition to a few smaller ones; mid- and hindcoxae with gray microtomentum; forefemur moderately swollen, with gray microtomentum and bearing a row of 6–8 strong setae on both posterodorsal and posteroventral surfaces, distal 2 or 3 usually strongest, many scattered smaller setae on remainder of posterior surface, otherwise evenly setulose; forefemoral anteroventral ctenidial comb of setae minute, shorter than width of foretibia; hindfemur moderately swollen; mid- and hindfemora with gray microtomentum, evenly setulose, anterior surface of midfemur with 1 stronger seta in middle; fore- and hindtibiae darkened on distal ½, yellow basally, midtibia yellow, tibiae evenly setulose; foretarsus brown, mid- and hindtarsi with apical 3 tarsomeres brown, basal 2 yellow.

Abdomen: Uniformly with pale gray microtomentum. Male terminalia (Figure 13): ventral lobe of epandrium slightly indented ventrally, posterior portion with a broad, rounded lobe;

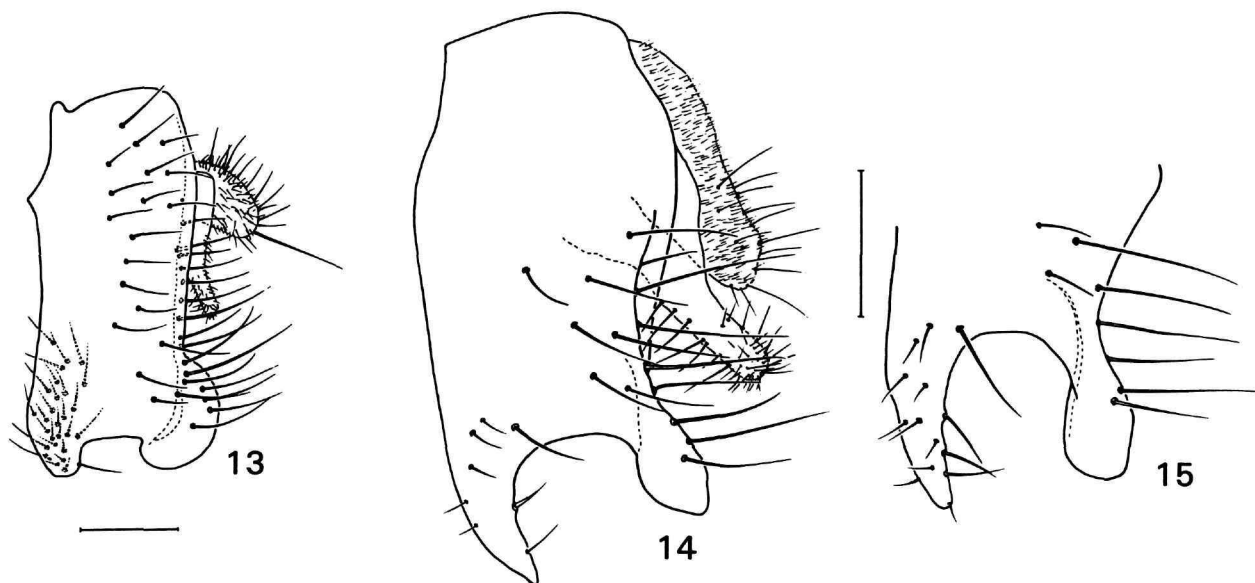

FIGURES 13–15.—External male terminalia: 13, *Pelomyia lobina*, lateral aspect; 14, *P. nubila*, lateral aspect; 15, ventral lobe of *P. nubila*, ventroblaque aspect. Scale bars = 0.1 mm (scale bar below Figure 13 applies only to that figure).

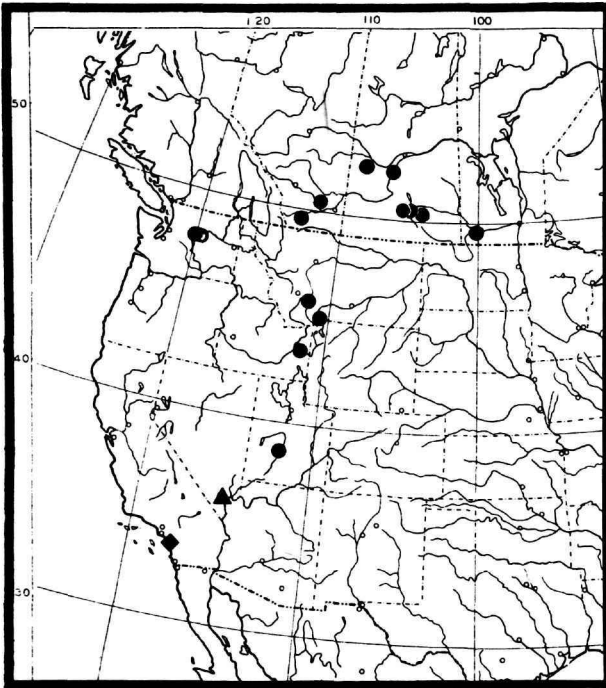

FIGURE 16.—Distribution map for *Pelomyia granditarsa* (triangle), *P. lobina* (dot), *P. nubila* (diamond), and *P. planibulla* (open circle).

margins bare, with moderately strong setae on anterior medial surface and many long fine setae on exterior surface of posterior lobe; surstylus reduced, bearing many minute setae distally; cercus normal (not elongate); aedeagus thick, pubescent; pregonite distinct, long, tapered, pointed; hypandrium stout in lateral view; distal portion of postgonite long, tapered, pointed; basiphallus long, pointed, triangular; ejaculatory apodeme moderately flared. Female terminalia: cercus bearing some slightly stronger setulae.

TYPE MATERIAL.—The holotype male is labeled “3-Forks, MONT[ANA,] 1 Aug. 1918[,] A.L. Melander/ALMelander Collection 1961 [green stippling on right third]/HOLOTYPE *Pelomyia lobina* ♂ Foster & W.N.Mathis USNM [red label; species name and ‘♂ Foster &’ handwritten].” The holotype is double mounted (minuten in a vertically mounted rectangular card), is in excellent condition, and is deposited in the USNM.

Paratypes are as follows: UNITED STATES. *Idaho*. Bonneville: Idaho Falls (4708 ft), 26 Jul 1926, R.W. Haegele (1♂; USNM). *Montana*. Park: Gardiner Valley, 20 Aug 1918, A.L. Melander (3♂, 3♀; USNM). *Utah*. Sevier: Richfield (light trap), 15 Jul 1929 (1♂; USNM). *Washington*. Okanogan: Pateros, 3 Aug 1919, A.L. Melander (4♂, 2♀; USNM). *Wyoming*. Albany: Laramie (University of Wyoming Agronomy Farm), 13 Aug 1956 (2♂; USNM).

CANADA. *Alberta*: Cassils (alfalfa blossom), 26 Jul 1923, W. Carter (1♂; CNC); Lethbridge, 6 Jul 1956, O. Peck (4♂; CNC). *Manitoba*: Whitewater Lake (4 mi N Whitewater; *Hardeum jubatum*), 14 Aug 1958, J.G. Chillcott, R.B. Hodge (1♂, 1♀; CNC). *Saskatchewan*: Blackstrap (*Artemisia biennis*), 13 Jul 1979, M.G. Maw (1♂; CNC); Fairy Hill (*Kochia scoparia*), 27 Jul 1979, M.G. Maw (1♂; CNC); Markinch (*Convolvulus*), 12 Jul 1979, M.G. Maw (1♂; CNC); Saskatoon, 9 Sep 1959, J.R. Vockeroth (1♂; CNC); Strongfield, 10 Sep 1959, J.R. Vockeroth (1♂; CNC); Wilkie (*Crepis tectorum*), 14 Jul 1979, M.G. Maw (1♀; CNC).

DISTRIBUTION (Figure 16).—Nearctic: Canada (AL, MB, SK), United States (ID, MT, UT, WA, WY).

ETYMOLOGY.—The species epithet, *lobina*, is of Latin derivation and alludes to the diminutive lobe of the ventral process.

REMARKS.—Hardy and Delfinado (1980:377), while discussing specimens of *P. steyskali*, noted that a male and female collected by O. Peck on 7 July 1956 represented a second species from the same locality. They concluded that these specimens “may belong to [*steyskali*].” We examined four males collected by Peck (6 Jul 1956) and have determined that they represent this species.

4. *Pelomyia nubila* Melander

FIGURES 5, 6, 14–16

Pelomyia nubila Melander, 1952:195.—Vockeroth, 1965:726 [Nearctic catalog].—Cole, 1969:386 [distribution, diagnosis].—Mathis and Munari, 1996:9 [world catalog].

DIAGNOSIS.—This species is distinguished from congeners by the following combination of characters: body with brownish gray microtomentum; frons yellowish orange, darker near ocellar triangle; parafrenal setulae few, minute; fronto-orbital seta 1, reclinate; antenna mostly yellow, only small area near base of arista brown; oral vibrissae weakly developed but distinct; gena approximately 0.25–0.32 times eye height; mesonotum with 3 faint brownish stripes along line of dorsocentral setae and along midline; dorsal ½ of anepisternum slightly darker than ventral ½, microtomentose; acrostichal setulae few, minute, in 2 scattered rows; wing crossveins faintly infuscate; forecoxa white in base color; forefemur moderately swollen; hindfemur barely swollen, entirely yellow; foretibia brown on distal ½; mid- and hindtibiae yellow; forefemoral anteroventral ctenidial comb of setae short (shorter than width of foretibia) and weakly developed; tarsomeres of normal size.

DESCRIPTION.—Body length approximately 2.50 mm; body generally with brown to brownish gray microtomentum.

Head: Ocellar triangle grayish, microtomentose; frons yellowish orange, extreme margins silvery gray, microtomentose; frontal lunule white; parafrenal setulae few, minute, with 1 slightly larger seta near base of antenna; ocellar seta 1, strong, another 2 or 3 minute, weak ocellar setulae; paravertic setae moderately well developed, widely separated, convergent. Antenna mostly yellow, only small area near base of arista brown.

Gena approximately 0.25–0.32 times eye height, with whitish yellow microtomentum and bearing many minute, scattered setulae; shiny chitinous stripe along parafacial and peristomal margins; palpus yellow; clypeus brown.

Thorax: Mesonotum mostly with grayish microtomentum and bearing brown stripe along dorsocentral setae and medially along acrostichal setulae; dorsal ½ of anepisternum slightly darker than ventral ½, remainder of pleural surfaces mostly with gray microtomentum. Wing mostly hyaline, with faint infuscation on crossveins; costal section ratios 6.3:1.7:1.2. Forecoxa white in base color, with whitish yellow microtomentum, with 2 or 3 large setae in addition to a few smaller ones; mid- and hindcoxae mostly with yellow to very pale gray microtomentum; forefemur moderately swollen, mostly with brown microtomentum and bearing a row of 6–8 strong setae on both posterodorsal and posteroventral surfaces, distal 2 or 3 sometimes longest, many scattered smaller setae on remainder of posterior surface, otherwise evenly setulose; forefemoral anteroventral ctenidial comb of setae indistinct to weak, shorter than width of foretibia; hindfemur barely swollen; mid- and hindfemora entirely yellow, evenly setulose with anterior surface of midfemur bearing 1 stronger seta in middle; foretibia with brownish microtomentum on distal ½, yellowish basally, evenly setulose; mid- and hindtibiae entirely yellow, evenly setulose; foretarsus entirely brown, mid- and hindtarsi with basal 3 or 4 tarsomeres yellow, distal 1 or 2 tarsomeres brown.

Abdomen: With microtomentum brownish dorsally becoming gray laterally, extreme posterior margin of each tergite yellow. Male terminalia (Figures 5, 6, 14, 15): ventral lobe of epandrium deeply bifurcate, anterior margin bare, posterior margin bearing several setulae, anterior tine of bifurcation pointed and curved posteriorly, posterior tine spatulate; surstylus short, spatulate, bearing many setulae distally; aedeagus thick, pubescent; pregonite distinct, long, tapered, pointed, partly fused with postgonite; hypandrium in lateral view narrow; distal portion of postgonite long, tapered, pointed; basiphallus long, pointed, triangular; ejaculatory apodeme moderately flared. Female terminalia: cercus bearing fine setulae only.

TYPE MATERIAL.—The lectotype male of *Pelomyia nubila* Melander, herein designated to stabilize and make more universal the use of this name, is labeled “San Clemente 18/X/44 [18 Oct 1944] CAL[ifornia.] A.L.Melander/HOLOTYPE *Pelomyia nubila* Melander [red]/ALMelander Collection 1961 [green stippling on right side]/LECTOTYPE ♂ *Pelomyia nubila* Melander By Foster & Mathis [handwritten except for ‘LECTOTYPE’ and ‘By’; black submarginal border].” The lectotype male is double mounted (vertically mounted minutes in a cardboard rectangle), is in excellent condition (abdomen removed, dissected, structures in an attached microvial), and is deposited in the USNM.

Paralectotypes are as follows: UNITED STATES. *California*. Orange: Corona del Mar, San Clemente (3♂, 5♀; USNM) (Melander, 1952:195). Although the lectotype bears a holotype

label, Melander did not publish this designation in his paper. Thus, we have designated a lectotype herein.

DISTRIBUTION (Figure 16).—Nearctic: United States (CA).

REMARKS.—This species and *P. occidentalis* are very similar and may be conspecific. Unfortunately, we lack adequate specimens for a thorough analysis, especially the minor differences noted in structures of the male terminalia, such as the longer anterior tine of the ventral lobe in *P. nubila*. Externally, however, there are marked differences in leg and antennal coloration and in the faint infuscation of the crossveins. In addition, the specimens of each species are apparently allopatric. For the present we continue to recognize both species.

5. *Pelomyia occidentalis* Williston

FIGURES 17–21

Pelomyia occidentalis Williston, 1893:258; 1908:307 [key, figures of head, thorax].—Curran, 1934:330 [figure of head, copy of Williston, 1908].—Vocckerth, 1965:726 [Nearctic catalog].—Mathis and Munari, 1996:9 [world catalog].—Irwin et al., 2001:153–156 [key, discussion, biology, figures, list, Germany, Great Britain].

Pelomyia coronata of authors [misidentification].—Melander, 1913b:297 [in part; synonymy]; 1952:193 [in part; revision].—Hendel, 1917:46 [in part; revision]; 1934:51 [in part; revision].—Sturtevant, 1923:7 [in part; list and revision].—Malloch, 1934:456 [discussion].—Hennig, 1939:82 [figure of male terminalia].—Cole, 1969:386 [in part; discussion].—Szadziewski, 1983:47 [list, Poland; ecology, figures of male terminalia].

Pelomyia steyskali Hardy and Delfinado, 1980:375.—Mathis and Sasakawa, 1989:667 [Australasian/Oceanian catalog].—Roháček, 1992:128–129 [discussion, ecology, Czech Republic, Hungary, Poland, Slovakia].—Mathis and Munari, 1996:9 [world catalog]. [New Synonym.]

Pelomyia species.—Zuska and Laštovka, 1969:207 [list, Czech Republic].

DIAGNOSIS.—This species is distinguished from congeners by the following combination of characters: body with brownish gray microtomentum; frons yellowish orange, darker near ocellar triangle; parafacial setulae few, minute, 1 slightly larger seta near base of antenna; fronto-orbital seta 1, reclinate; antenna mostly brown with distal margin and medial surface of 1st flagellomere orange; oral vibrissae weakly developed but distinct; gena approximately 0.20–0.28 times eye height; mesonotum with 3 faint brownish stripes along line of dorsocentral setae and along midline; dorsal ½ of anepisternum brownish, ventral ½ gray, microtomentose; acrostichal setulae few, minute, in 2 scattered rows; wing crossveins not infuscate; forecoxa white in base color; forefemur moderately swollen; hindfemur barely swollen; tibiae brown to black; forefemoral anteroventral ctenidial comb of setae short (shorter than width of foretibia) but moderately strong; tarsomeres of normal size.

DESCRIPTION.—Body length 2.10–3.00 mm; body generally with brown to brownish gray microtomentum.

Head: Ocellar triangle grayish, microtomentose; frons yellowish orange, extreme margins silvery gray, microtomentose; frontal lunule silvery; parafacial setulae few, minute, with 1 slightly larger seta near base of antenna; ocellar seta 1, strong, another 2 or 3 minute, weak ocellar setulae; paravertic setae short, weak, widely separated, convergent. Antenna

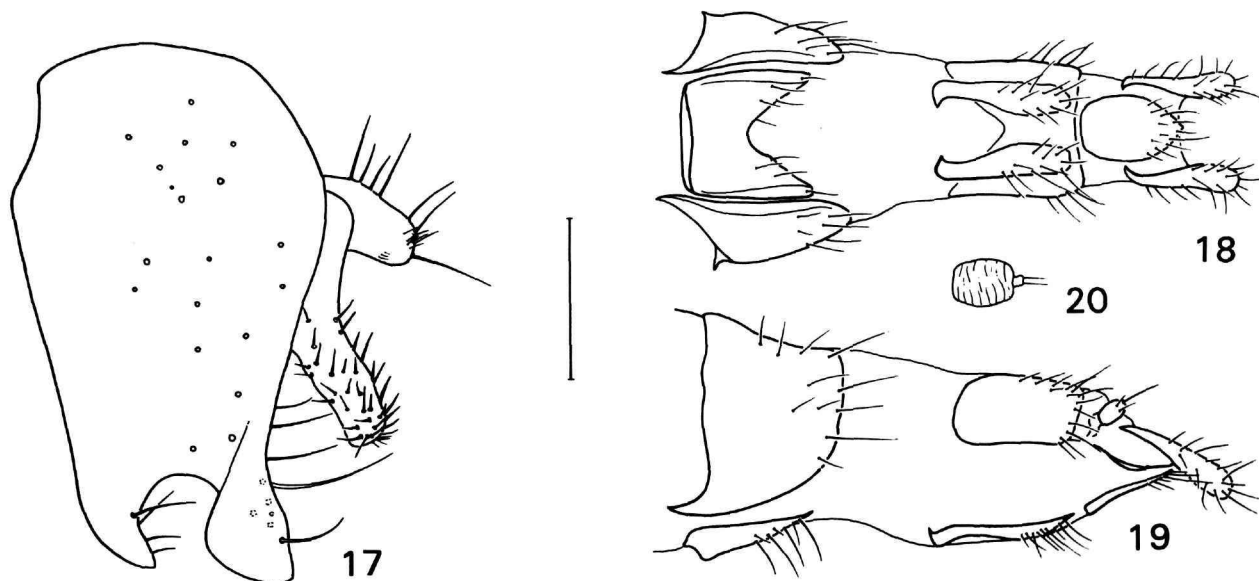

FIGURES 17–20.—*Pelomyia occidentalis* Williston: 17, epandrium, cercus, and surstylus, lateral aspect; 18, female postabdomen, ventral aspect; 19, same, lateral aspect; 20, spermatheca, lateral aspect. Scale bar = 0.1 mm for Figure 17 only; scale is unknown for Figures 18–20 (pencil drawings prepared by George C. Steyskal).

mostly brown, only distal margin and entire medial surface of 1st flagellomere orange. Gena approximately 0.20–0.28 times eye height, with whitish yellow microtomentum and bearing many minute, scattered setulae; shiny chitinous stripe along parafacial and peristomal margins; palpus yellow; clypeus brown.

Thorax: Mesonotum mostly with grayish microtomentum and bearing brown stripe along line of dorsocentral setae and centrally along acrostichal setulae; dorsal ½ of anepisternum with brown microtomentum and ventral ½ with gray microtomentum, remainder of pleural surfaces mostly with gray microtomentum. Wing hyaline; costal section ratios 7.0:1.5:1.0. Forecoxa white in base color, with white microtomentum, with 2 or 3 large setae in addition to a few smaller ones; midcoxa partly yellow, gray basally; hindcoxa gray; forefemur moderately swollen, with gray microtomentum and bearing a row of 6–8 strong setae on both posterodorsal and posteroventral surfaces, distal 2 or 3 sometimes longest, many scattered smaller setae on remainder of posterior surface, otherwise evenly setulose; forefemoral anteroventral ctenidial comb of setae distinct, moderately strong, shorter than width of foretibia; hindfemur barely swollen; mid- and hindfemora gray, evenly setulose with anterior surface of midfemur bearing 1 stronger seta in middle; tibiae with brownish to blackish microtomentum, rarely slightly paler on basal ½ of mid- and hindtibiae, evenly setulose; foretarsus entirely gray, mid- and hindtarsi with basal 3 tarsomeres yellow, distal 2 tarsomeres brown.

Abdomen: With microtomentum brownish dorsally becoming gray laterally, extreme posterior margin of each tergite yellow.

low. Male terminalia (Figure 17): ventral lobe of epandrium deeply bifurcate, anterior margin bare, posterior margin bearing several setulae, anterior tine pointed and curved posteriorly, posterior tine of bifurcation spatulate; surstylus short, spatulate, bearing many setulae distally; aedeagus thick, pubescent; pregonite distinct, long, tapered, pointed, partly fused with postgonite; hypandrium in lateral view narrow; distal portion of postgonite long, tapered, pointed; basiphallus long, pointed, triangular; ejaculatory apodeme moderately flared. Female terminalia: cercus bearing fine setulae only (Figures 18, 19); spermatheca as in Figure 20.

TYPE MATERIAL.—The lectotype female of *Pelomyia occidentalis* Williston, herein designated to stabilize and make more universal the use of this name, is labeled “Monterey Co. CAL[IFORNIA]./Through C V Riley/TYPE No. A. M. N. H. [red]/Am. Mus. Nat. Hist. Dept. Invert. Zool. No. 20330 [number handwritten]/*Pelomyia occidentalis* Will. [handwritten; two red submarginal borders]/LECTO-TYPE [circular label with a black border]/LECTOTYPE ♀ *Pelomyia occidentalis* Williston 1893 det. A. Irwin 1983 [handwritten]/LECTOTYPE ♀ *Pelomyia occidentalis* Williston By Foster & Mathis [handwritten except for ‘LECTOTYPE’ and ‘By’; black submarginal border].” The lectotype is double mounted (glued to a thin strip of celluloid), is in poor condition (right wing and several setae missing, thorax cracked), and is deposited in the AMNH (20330). Although A.G. Irwin studied this specimen and attached a lectotype label to it, the designation was never published and is thus invalid. In the original description, Williston also listed a male syntype, which we were unable to locate.

Irwin (in litt. to W.N.M., 2001) also searched for this specimen in 1983 and was unable to find it.

The holotype male of *Pelomyia steyskali* Hardy and Delfinado is labeled "OREGON Curry Co 8miN Gold Beach VI-29-72 [29 Jun 1972] George Steyskal/Holotype ♂ *Pelomyia steyskali* Hardy & Delfinado [red label; handwritten]/*Pelomyia steyskali* Hardy & Delfinado Det. D. E. Hardy [species name and authors handwritten]." The holotype is double mounted (minuten in a block of white plastic), is in good condition (some cephalic setae are missing), and is deposited in the USNM.

OTHER SPECIMENS EXAMINED.—UNITED STATES. *Arizona*. Yuma: Yuma, 8 Apr 1947, A.L. Melander (1♀; USNM). *California*. Alameda: Bay Farm, 10 May 1921, W.M. Giffard (1♂; CAS); Berkeley, 4 Oct 1947, W.W. Wirth (1♀; USNM); San Leandro, 14 Jan–19 Nov 1947, 1948, W.W. Wirth (2♂; USNM). Contra Costa: Antioch, 18 Oct 1936, R.C. Dickson (1♂; USNM); El Sobrante, 5 Jun 1949, R.E. Ryckman (1♂; USNM); Richmond, 16 Feb–28 Dec 1947, 1948, W.W. Wirth (7♂, 7♀; USNM). Del Norte: Crescent City, 10 Jul 1930, J.M. Aldrich (3♀; USNM); Crescent City (18.5 mi N), 28 Jun 1972, W.N. Mathis, G.C. Steyskal (2♀; USNM); Smith River, 17 Jul 1930, J.M. Aldrich (4♂, 5♀; USNM). Humboldt: Clam Beach, 21 Jun 1935, A.L. Melander (2♀; USNM); Dyerville, 20 Jun 1935, A.L. Melander (1♀; USNM); Orick, 18 Sep 1934, A.L. Melander (1♂; USNM). Kern: Arvin, 14 Mar 1935, A.L. Melander (4♂, 3♀; USNM); Bakersfield (19 mi E), 24–26 Mar 1947, P.H. Arnaud (1♂; USNM); Mojave Desert, Roger Dry Lake, 16 Mar 1935, A.L. Melander (1♀; USNM). Lake: Clear Lake, 18 Jun 1935, A.L. Melander (1♂, 1♀; USNM). Los Angeles: Lovejoy Lake, 10 May 1944, A.L. Melander (2♂; USNM); San Gabriel Mountains, King Creek, A.L. Melander (1♀; USNM). Marin: Bolinas, 5 Jun 1949, R.E. Ryckman (1♀; USNM); China Camp, 16 Jun 1958, F.D. Bennett (1♂, 1♀; CNC); McClure's Beach, 8 Jul 1961, C.A. Toschi (1♂, *P. steyskali* paratype; CNC). Monterey: Asilomar, 11 Jul–3 Oct 1946, 1954, 1957, 1960, A.L. Melander (9♂, 6♀; USNM); Monterey, 1 Jul–25 Sep 1896, 1934, A.L. Melander (2♂; USNM); Monterey Peninsula (on seashore), 5 Jul 1973, J.R. Vockeroth (1♂; CNC); Pacific Grove, 13 Jun–28 Jul, 1920, 1940, 1969, B. Hocking, W.H. Mann, A.L. Melander (4♂, 4♀; CNC, USNM); Pacific Grove, Point Pinos, 13 Jun 1959, P.H. Arnaud (1♀; USNM). Napa: Calistoga, 28 May 1952, P.H. Arnaud, Jr. (4♂, 1♀; CAS); Vallejo (5 mi N), 7 Sep 1952, P.H. Arnaud (7♂; USNM). Nevada: Donner Lake, 10 Sep 1952, P.H. Arnaud (1♀; USNM). Orange: Buena Park, 23 Dec 1944, A.L. Melander (2♂; USNM); Corona del Mar, 13 Aug 1949, A.L. Melander (1♀; USNM); Huntington Beach, 4 Jun 1945, A.L. Melander (2♂; USNM); Laguna Beach, 21 Mar–18 Aug, 1943, 1951, A.L. Melander, H.D. Stalker (2♂; USNM); San Clemente, 5 Jun 1945, A.L. Melander (1♂; USNM). Riverside: Deep Creek, 25 Jan 1953, A.L. Melander (1♂; USNM); Indio, 6 Mar 1955, W.R. Richards (1♂; CNC); Lake Elsinore, 10 May 1950, A.L. Melander (1♀; USNM); Palm Springs, 20 Nov

1943, A.L. Melander (1♀; USNM); Palm Springs, Palm Canyon, 15 Mar 1955, W.R. Richards (1♀; CNC); Riverside, 5 May–9 Jul 1940, 1953, A.L. Melander (2♀; USNM); Palm Canyon, 12 Jan 1953, P.H. Arnaud (1♂; USNM); Temecula, 4 Apr–7 Jun 1945, 1949, A.L. Melander, W.W. Wirth (2♂; USNM); Thermal, 14 Mar 1955, W.R. Richards (1♂; CNC); Thousand Palms, 28 Mar 1955, W.R.M. Mason (1♂; CNC); 25 Mar 1955, W.R. Richards (1♂, *P. steyskali* paratype; CNC); Thousand Palms, Thousands Palms Oasis, 10–18 Mar 1955, W.R.M. Mason, W.R. Richards (2♂, 7♀; CNC); Thousand Palms, Willis Palms Oasis, 25 Mar–3 Apr 1955, W.R. Richards (3♂, 1♀; CNC); White Water Canyon, 6–7 Apr 1949, W.W. Wirth (2♂; USNM). San Benito: Idria (3500 ft) (5♂, 2♀; USNM). San Bernardino: Cajon Pass, 28 Apr 1949, A.L. Melander (1♂; USNM); Crestline, 13 Jul 1944, A.L. Melander (1♀; USNM); Helendale, 18 May 1955, W.R. Richards (1♂; CNC); Upper Santa Ana River, 13 Jul 1950, A.L. Melander (1♀; USNM). San Diego: Borrego, 4 Nov 1949, G. and J. Sperry (1♂; USNM); Carlsbad, 24 Jun 1954, A.L. Melander (12♂; USNM); La Jolla, 28 Mar 1946, A.L. Melander (1♂; USNM); San Diego, Apr–30 Dec 1913, 1934, H.G. Dyer, A.L. Melander, E.P. VanDuzee (3♂, 3♀; CAS, USNM). San Francisco: San Francisco, 22 Jun–1 Aug 1915, 1947, J.E. Aldrich, A.L. Melander (8♂, 5♀; CAS, USNM); San Francisco, Lake Merced, 1 Aug 1964, P.H. Arnaud, Jr. (1♀; CAS). San Luis Obispo: Cholame Creek (1 mi S Cholame), 1 May 1963, P.H. Arnaud, Jr., H.B. Leech (3♂, 1♀; CAS); Morro Bay, 16 Jun–29 Jul 1940, 1945, 1947, A.L. Melander (4♂; USNM); Pismo, 26 Jul 1940, A.L. Melander (1♂, 1♀; USNM); San Simeon, 31 Aug 1945, A.L. Melander (1♂; USNM); Soda Lake (south end; 15 mi SE Simmler), 2 Apr 1969, H.B. Leech (2♂, 1♀; CAS); Tremblor Range (12 mi E Simmler; 3200 ft), 25 Apr 1964, J. Powell (1♂; CNC). San Mateo: Half Moon Bay, 3–19 Jul 1958, 1959, P.H. Arnaud (1♂, 1♀; USNM); Jasper Ridge, 15 Aug 1957, P.H. Arnaud (1♀; USNM); Redwood City (1♂, ex flowers *Foeniculum vulgare*), 3 May–6 Sep 1946, 1947, 1949, 1952, 1953, 1957, P.H. Arnaud (7♂, 4♀; USNM). Santa Barbara: Carpinteria, 12 Jun–11 Aug 1947, 1950, 1953, 1958, A.L. Melander (5♂, 3♀; USNM). Santa Clara: Mount Hamilton, 15 Apr 1947, G. Bohart (1♀; USNM); Stanford: 15 Jul–13 Nov 1952, 1953, 1957, P.H. Arnaud, A.L. Melander (10♂, 11♀; USNM). Santa Cruz: Big Basin, 18 Jul 1954, A.L. Melander (5♂; USNM); Felton, 17–18 May 1947, P.H. Arnaud (1♀; USNM); Santa Cruz, 30 Aug 1952, P.H. Arnaud (3♂, 2♀; USNM). Solano: Maine Prairie (swept from tules), 14 Jun 1921, B.G. Thompson (3♀; USNM). Sonoma: Bodega Mar. Station, 3 May 1968, D.D. Munroe (12♂, 23♀; CNC); Sonoma (2000 ft), J.A. Kushe (1♂; USNM). Stanislaus: Westley, 1 Apr 1948, P.D. Hurd (1♂; USNM). Ventura: Hueneme (salt marsh), 17 Jun 1948, W.W. Wirth (2♀; USNM); San Nicolas Island, Celery Canyon (100 ft), 22–26 Jun 1978, A.S. Menke, R.W. Rust (1♀; USNM); Sisar Creek, 16 Jun 1948, W.W. Wirth (1♀; USNM). *Hawaii*. Oahu: Kailua (at window near beach), 1 Jun 1946, W.W. Wirth (9♂; USNM). *Idaho*. Bannock: Tyhee

(on *Beta vulgaris*), 18 Sep 1931, D.E. Fox (1♂; USNM). Latah: Potlatch, 20 Sep 1919, A.L. Melander (1♀; USNM). Nez Perce: Lewiston, 5 Jun 1930, J.M. Aldrich (1♀; USNM). Twin Falls: Castleford (beets), 13 Aug 1929, Gillette (1♀; USNM); Twin Falls (sugar beet study), 24 Aug–1 Sep 1940 (2♂, 6♀; USNM). *Nevada*. Nye: Ash Meadows National Wildlife Refuge (Crystal Spring; 36°25.2'N, 116°19.8'W), 12 May 2001, D. and W.N. Mathis (1♂; USNM). Storey: Reno, 23 Jul–3 Nov 1915, H.G. Dyer (4♂; USNM). Washoe: Pyramid, 4–5 Jul 1947, R.L. Usinger (1♂; USNM). *New Mexico*. Otero: High Rolls, 2 Jun 1902 (1♀; USNM). *Ohio*. Butler: Oxford, Mallot's Lawn, 26 Sep 1978, B.A. Steinly (1♀; USNM). Lorain: Beaver Creek (near Amherst; 41°24.2'N, 82°14.0'W), 30 Jun 1977, B.A. Steinly (2♀; USNM). *Oregon*. Linn: Breitenbush Springs (2222 ft), 6 Jul 1934, H.A. Scullen (1♂; USNM). Tillamook: Sand Lake (2 mi S), 13 Jun 1972, W.N. Mathis (1♀; USNM). Umatilla: Umapine, 21 Jun 1921, A.L. Melander (1♂; USNM). *Utah*. Beaver: Mirror Lake, Wasatch Mountains, 5 Aug 1956, A.L. Melander (1♀; USNM). Kane: Drip Tank Canyon (37°19.4'N, 111°31.8'W), 15 May 2001, D. and W.N. Mathis (1♂; USNM). Salt Lake: Salt Lake City, 24 Jun 1940, A.L. Melander (1♂, 2♀; USNM). Sevier: Richfield (on *Beta vulgaris* and *Salsola pestifer*), 15 Jul–21 Sep 1929, H.E. Dorst, D.N. Fox (1♂, 2♀; USNM). Tooele: Flux, 4 Aug 1940, D.G. Hall (2♀; USNM). Utah: Goshen Warm Spring (6.9 km W Santiquen; 39°58'N, 111°56'W), 4 Aug 1992, D. and W.N. Mathis (5♂, 2♀; USNM); Spanish Fork, D.E. Hardy (1♂, 1♀; USNM). Washington: Washington, 13 May 1958, G.F. Knowlton (1♀; USNM); Zion National Park, 20 Apr 1935, A.L. Melander (1♂; USNM). *Washington*. Adams: Othello (3.2 km W; 46°50'N, 119°14'W), 23 Jul 1992, D. and W.N. Mathis (5♂; USNM). Asotin: Clarston, 15 May 1912, A.L. Melander (2♀; USNM). Benton: Kennewick, 20 May–7 Jun 1916, 1921, A.L. Melander (4♂, 10♀; USNM); Prosser, 4 May 1911 (5♂; USNM). Chelan: Entiat, 26 Jul 1919, A.L. Melander (1♀; USNM); Lake Chelan, Stehekin, 30 Jul 1919, A.L. Melander (2♀; USNM). Clallam: Blyn (48°1.3'N, 123°0.4'W), 10 Aug 1921, A.L. Melander (5♀; USNM); Blyn (salt marsh), 24 Jul 1917, A.L. Melander (1♀; USNM); Dungeness, 24 Aug 1910 (6♂, 2♀; USNM); Sequim Bay, 3 Sep 1934, A.L. Melander (4♂, 7♀; USNM). Franklin: Ringold (NW of Pasco; 46°30.3'N, 119°15.3'W), 30 Jul 1998, W.N. Mathis (1♂, 1♀; USNM). Island: Whidbey Island, near Keystone Ferry, 18 Sep 1975, G.F. Hevel (1♀; USNM). King: Seattle, 2 Aug 1908 (1♀; USNM). Klickitat: Klickitat River, 20 May 1921, A.L. Melander (1♂; USNM). Mason: Dewatto (47°27.1'N, 123°4.3'W), 15 Aug 1910 (1♀; USNM). Okanogan: Pateros, 3 Aug 1919, A.L. Melander (1♀; USNM). Pierce: Mt. Rainier, Ohanapecosh, 11 Aug 1940, A.L. Melander (1♀; USNM). San Juan: Olga, 20 Jul (1♂; USNM); Orcas Island, North Beach, 19 Aug 1925, A.L. Melander (2♀; USNM). Snohomish: Mukilteo, Jul 1924, A.L. Melander (2♂; USNM). Whitman: Almota, 2 Jun 1928, A.L. Melander (1♀; USNM). Yakima: North Yakima, 19 May 1917, 1941, A.L. Melander, Reeves and

Brookman (6♀; CAS, USNM); Yakima, 18 Jul 1920, A.L. Melander (1♂, 2♀; USNM).

CANADA. *British Columbia*: Chilliwack, MacGillivray Creek Game Preserve, 14 Jul 1953, G.J. Spencer (1♀; CNC); Cranbrook, 14 Aug 1926, A.A. Dennys (1♀; CNC); Kamloops, 11 Jun 1972, N.L.H. Krauss (1♀; USNM); Ladysmith, 2 Jun 1955, R. Coyles (1♂; CNC); Oliver, 21 May–18 Aug 1923, 1953, C.B. Garrett, J.R. McGillis (2♀; CNC); Osoyoos, 29 Aug 1924, A.L. Melander (1♀; USNM); Summerland, 13 May–23 Sep 1931, 1959, 1960, A.A. Dennys, A.N. Gartrell, R.E. Leech (4♂, 9♀; CNC); Vancouver, Point Grey (on tidal flat), 5 Jul–21 Aug 1972, 1973, J.R. Vockeroth (1♂, 1♀; CNC); Vernon, 30 Sep 1926, I.J. Ward (1♀; CNC). *Manitoba*: Winnipeg, Brady Road Landfill, 25 Aug 1977 (1♂, 1♀; CNC).

MEXICO. *Baja California Norte*: San Carlos (Agua Caliente; 18.5 km E Maneadero), 6 Jul 1973, P.H. Arnaud, Jr. (1♂; CAS); San Vicente (0.5 mi N), 21 Apr 1963, P.H. Arnaud, Jr., H.B. Leech (17♂, 4♀; CAS); Tijuana (60 km S), 26 Jun 1950, A.L. Melander (1♀; USNM). *México*: Toluca, 28 Apr 1965, N.L.H. Krauss (1♀; USNM).

DISTRIBUTION (Figure 21).—Australasian/Oceanian: Hawaiian Islands (Molokai, Oahu). Nearctic: Canada (BC, MB), United States (AZ, CA, HI, ID, NV, NM, OH, OR, UT, WA). Neotropical: Mexico (BCN, MEX). Palearctic: Czech Republic, England, Germany, Great Britain, Hungary, Poland, Slovakia. (The records from countries of the Palearctic Region are from the literature, as noted in the synonymy, or from A.G. Irwin, in litt. to W.N.M., 2001, and Irwin et al., 2001.)

NATURAL HISTORY.—This species occurs in a variety of habitats, often associated with terrestrial habitats that are adjacent to aquatic systems. The water quality in these systems varies tremendously from relatively pristine fresh water, to alkaline or saline, or even highly polluted (Melander, 1952; Vockeroth, 1965; Szadziewski, 1983; Roháček, 1992).

VARIATION.—Variation was noted in the coloration of legs, particularly the tibiae. Occasional specimens exhibit a slightly paler color on the basal half of the mid- and hindtibiae. The legs of *P. occidentalis*, however, are almost always conspicuously darker than those of *P. coronata*. Thus, most specimens of both sexes can be separated on the basis of the mid- and hindtibial coloration, which in *P. coronata* is partially yellow and in *P. occidentalis* is entirely grayish.

Melander (1952) noted considerable variation in the ventral lobe of the epandrium (his "claspers") of "*P. coronata*" (now *P. occidentalis*). He described continuous variation in form from straight and unforked to deeply bifurcate with branches of different lengths or to having no ventral lobe. Based upon examination of more than 400 specimens from Melander's collection, the variation he observed can be explained.

We observed that the epandrium of this species, after drying, may collapse on itself, causing the bifurcate lobes to dry into many configurations. The configurations vary from clearly bifurcate to appearing as if there were no ventral lobe. The anterior and posterior branches may also appear to vary in length

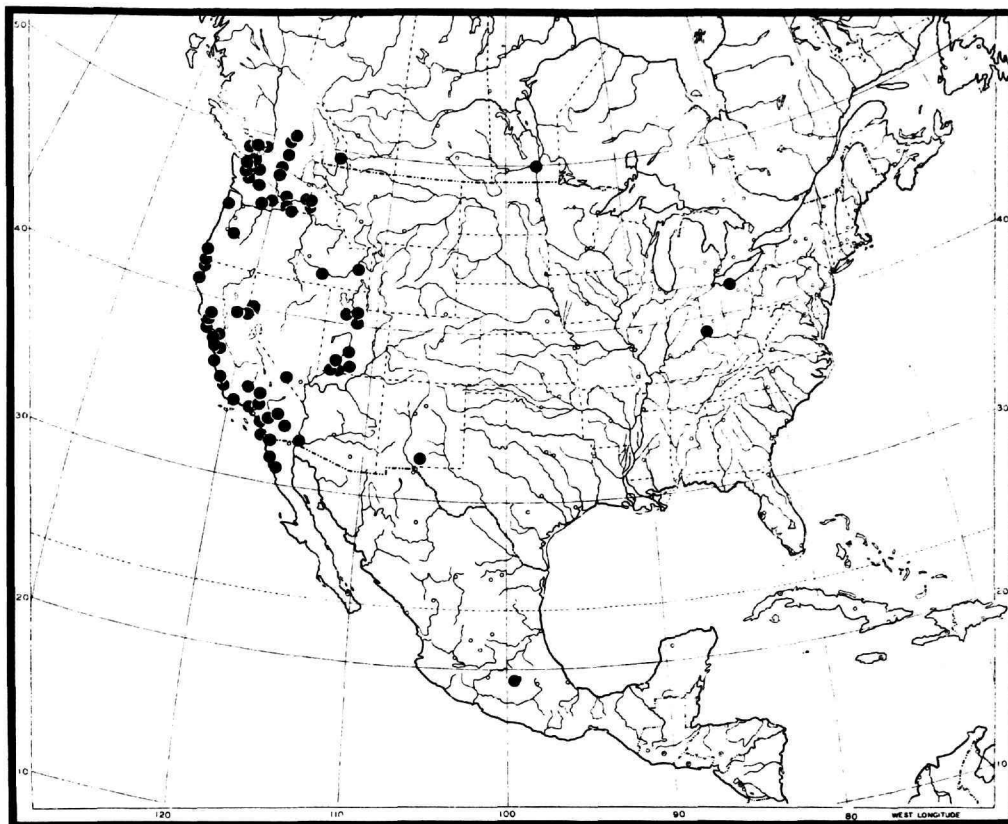

FIGURE 21.—New World distribution map for *Pelomyia occidentalis*.

because of the differential bending they may undergo. After maceration and rehydration of the terminalia, however, it is clear that there is very little variation in the shape of the ventral lobe of this species.

REMARKS.—Our concept of this species is based primarily on structures of the male and female terminalia and secondarily on the coloration of the legs. These structural and colorational characters seem to be consistent and diagnostic.

Melander (1913b) errantly considered this species and *P. coronata* (Loew) to be conspecific and the species' names to be synonyms. Because *P. coronata* was named earlier, *P. occidentalis* was thereafter largely overlooked and treated as a junior synonym by most subsequent authors (see synonymy of this species).

Melander's misidentification of *P. occidentalis* and its diminished nomenclatural status led in part to further confusion about the identity and correct name of this species. Hendel (1934), for example, clearly recognized two species in *Pelomyia* (the first with a straight ventral lobe of the epanthrium, the second with a bifurcate lobe). Not having convenient access to the appropriate types, he accepted Melander's synonymy of *P. occidentalis* with *P. coronata* and thus consid-

ered his second species to be undescribed. Hendel assumed or guessed incorrectly that *P. coronata* was the species with the bifurcate lobe and described the species with a straight ventral lobe as *P. cruciata*. He did not examine specimens of *P. occidentalis* or otherwise consider this species in his study.

Our examination of structures of the male terminalia revealed that *P. occidentalis* matches Hendel's concept of *P. coronata*. Moreover, Hendel's misidentified specimens of *P. coronata* are conspecific with specimens that Hardy and Delfinado (1980) later named as *P. steyskali*. Hardy and Delfinado, who likewise did not examine any types, stated that G.C. Steyskal had studied specimens of *P. cruciata* from the type locality (Atherton, Missouri) and confirmed the conspecificity of Hendel's species with Steyskal's concept of *P. coronata*. Steyskal concluded that the species with the bifurcate ventral lobe was undescribed and that *P. coronata* was the species with a straight ventral lobe. Steyskal's determination of *P. coronata* was correct, but he and Hardy and Delfinado overlooked the possibility that *P. occidentalis* was an available and valid name for their species.

This species was probably introduced into the Palearctic Region from the Nearctic Region (Roháček, 1992), perhaps as

early as the 1950s. The first records date from 1960 and are from Germany and eastern Bohemia (Czech Republic).

We also examined the female terminalia of both *P. coronata* and *P. occidentalis* and are publishing herein illustrations prepared by G. Steyskal (Figures 9–11, 18–20). The structural differences between these two species are minor but distinct and consistent. The most reliable difference is in the narrow ventral fusion of the 7th tergite and sternite in *P. coronata*, whereas in *P. occidentalis* the 7th tergite and sternite are clearly separated ventrally. There are generally minor differences in the shape of the 7th and 8th sternites between the species, but there is sufficient variation to make interpretation of these structures difficult, especially as diagnostic characters. An exception is the posterodorsal margin of the 7th tergite, which is nearly straight in *P. occidentalis* and strongly excised in *P. coronata*.

6. *Pelomyia intermedia* Malloch

FIGURE 22

Pelomyia intermedia Malloch, 1934:460.—Hennig, 1937:140 [citation].—Foster, 1976b:2 [Neotropical catalog].—Mathis and Munari, 1996:9 [world catalog].

DIAGNOSIS.—This species is distinguished from congeners by the following combination of characters: body with brownish gray microtomentum; frons yellowish orange; parafrontal setulae few, minute, 1 setula slightly larger near base of antenna; fronto-orbital seta 1, reclinate; antenna mostly brown with medial surface of 1st flagellomere mostly orange; oral vibrissae weak but distinct; gena approximately 0.42 times eye height; mesonotum with brown microtomentum; pleural areas mostly with gray microtomentum, dorsal ½ of anepisternum brown; acrostichal setulae few, minute, in 2 scattered rows; wing crossveins not infuscate; tarsomeres of normal size; forecoxa white in base color; mid- and hindfemora not swollen, entirely brown; forefemoral anteroventral ctenidial comb of setae short (shorter than width of foretibia), relatively weak, numerous.

DESCRIPTION.—Length of head and thorax 1.45 mm (abdomen removed for dissection); body generally with brown to gray microtomentum.

Head: Ocellar triangle with brownish gray microtomentum; frons yellowish orange; parafrons with whitish microtomentum; frontal lunule white; parafrons bearing a few, minute setulae, 1 slightly larger setula near base of antenna; ocellar setae 1 pair, strong, another 2 or 3 minute, weak ocellar setulae; paraverticilar setae short, weak, widely separate, convergent. Antenna mostly brown with medial surface of 1st flagellomere mostly orange. Gena approximately 0.42 times eye height, mostly with whitish microtomentum but with tinge of yellow near face and with many minute, scattered setulae; shiny chitinous stripe along parafacial and peristomal margins; palpus white; clypeus dark brown.

Thorax: Mesonotum with brown microtomentum; pleural areas mostly with gray microtomentum but with dorsal ½ of

anepisternum brown. Acrostichal setulae few, minute, in 2 scattered rows. Wing crossveins not infuscate; costal section ratios 5.8:1.5:1.2. Forecoxa pale brown to whitish in base color, with silvery microtomentum, with 2 or 3 large setae in addition to a few smaller ones; mid- and hindcoxae mostly brown with silvery microtomentum; forefemur not swollen, with brown microtomentum and bearing a row of 6–8 strong setae on both posterodorsal and posteroventral surfaces, distal 2 or 3 sometimes longest, many scattered smaller setae on remainder of posterior surface, otherwise evenly setulose; forefemoral anteroventral ctenidial comb of setae weak, shorter than width of foretibia; hindfemur not swollen; mid- and hindfemora entirely

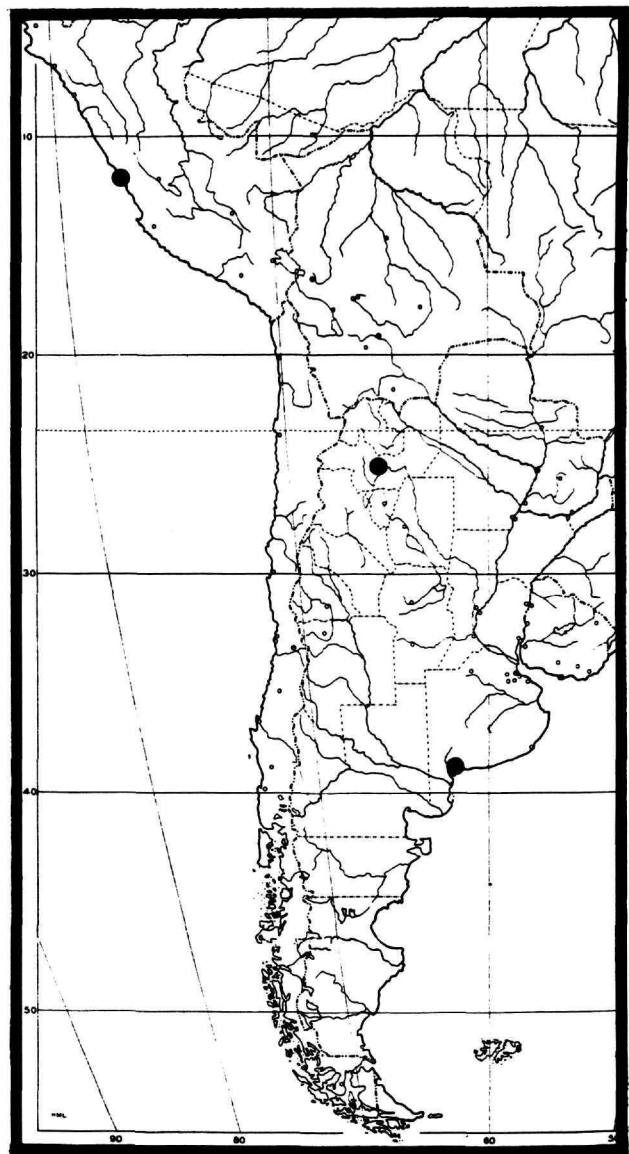

FIGURE 22.—Distribution map for *Pelomyia intermedia* Malloch.

brown, evenly setulose with anterior surface of midfemur bearing 1 stronger seta in middle; tibiae mostly black, microtomentose on distal $\frac{3}{4}$, yellow basally, evenly setulose; tarsi black.

Abdomen: Male unknown. Female cercus bearing fine setulae only.

TYPE MATERIAL.—The holotype female of *Pelomyia intermedia* is labeled "Type [round label with a red border]/*Pelomyia intermedia* Type det. JRMalloch [black subborder; '*Pelomyia intermedia* Type' handwritten]/Bahia Blanca. 23.x.1926. [23 Oct 1926]/Argentina: Buenos Aires. F.& M.Edwards. B.M. 1927-63." The holotype is double mounted (pin in a rectangular sheet of celluloid), is in excellent condition (abdomen removed, dissected, and in an attached microvial), and is deposited in the BMNH.

OTHER SPECIMENS EXAMINED.—ARGENTINA. *Salta:* Rosario de Lerma, 24 Feb 1992, S.A. Marshall (1♀; GUE).

PERU. *Lima:* Lima, Belen Station (railroad station), 4 Mar 1953, J.A. Munro (1♀; USNM).

DISTRIBUTION (Figure 22).—Neotropical: Argentina (Buenos Aires, Salta), Peru (Lima).

REMARKS.—The only known specimens of this species are the female holotype and two additional females from Argentina and Peru. We continue to recognize this species, despite the lack of any males for study, because these specimens do not key to any other species nor do they agree with other descriptions. This species is similar to *P. nubila*, *P. lobina*, and *P. planibulla* in having the forecoxa white but differs in having a much higher gena. Among species of the *coronata* group, this species is most similar to *P. coronata* but differs from it in the coloration of the thorax and tarsi. We have noted several other minor differences as well.

We included this species in the key to males without actual study of a male because all other males of *Pelomyia* are similar to females for the characters used in the key.

7. *Pelomyia planibulla*, new species

FIGURES 16, 23

DIAGNOSIS.—This species is distinguished from congeners by the following combination of characters: body with brownish gray microtomentum; postpronotal, notopleural, and anatergal surfaces slightly paler; frons yellow, parafrons with silvery microtomentum; parafrontal setae few, minute, 1 slightly larger seta near base of antenna; fronto-orbital seta 1, reclinate; antenna mostly brown, 1st flagellomere orange distally and medially; oral vibrissae minute, weak; gena 0.28 times eye height; acrostichal setulae minute, in 2 scattered rows; wing crossveins not infusate; tarsomeres of normal size; forecoxa white in base color; mid- and hindfemora not swollen, pale gray; forefemoral anteroventral ctenidial comb of setae minute, shorter than width of foretibia.

DESCRIPTION.—Combined length of head and thorax 1.20 mm; body generally with brownish gray microtomentum.

Head: Ocellar triangle with silvery gray microtomentum; frons yellow, parafrons with silvery microtomentum; frontal lunule silvery, parafrontal setulae few, minute; ocellar setae 1 pair, strong, another pair of minute, weak ocellar setulae; paravertical setae minute, widely separated, and convergent. Antenna mostly brown, only distal $\frac{1}{2}$ and entire medial surface of 1st flagellomere orange. Gena 0.28 times eye height, with white microtomentum, bearing many minute, scattered setulae; shiny chitinous stripe along parafacial and peristomal margins; palpus yellow; clypeus with brown microtomentum.

Thorax: Mesonotum mostly with brownish gray microtomentum, paler gray on postpronotal, notopleural, and anatergal surfaces; pleural sclerites mostly with gray microtomentum but with dorsal $\frac{1}{2}$ of anepisternum distinctly brown. Wing hyaline; costal section ratios 7.0:1.5:1.0. Forecoxa white in base color, with white microtomentum, with 2 or 3 large setae in addition to a few smaller ones; mid- and hindcoxae brownish gray; forefemur moderately swollen, with dark gray microtomentum and bearing a row of 6–8 strong setae on both posterodorsal and posteroventral surfaces, distal 2 or 3 usually strongest, many scattered smaller setae on remainder of posterior surface, otherwise evenly setulose; forefemoral anteroventral ctenidial comb of setae minute but numerous, shorter than width of foretibia; hindfemur barely swollen; mid- and hindfemora with pale gray microtomentum, evenly setulose, anterior surface of midfemur without a stronger seta in middle; tibiae darkened on distal $\frac{1}{2}$, yellow basally, evenly setulose; tarsi yellowish to brown.

Abdomen: Male terminalia (Figure 23): ventral lobe of epandrium broadly truncate, lateral and medial surfaces bearing

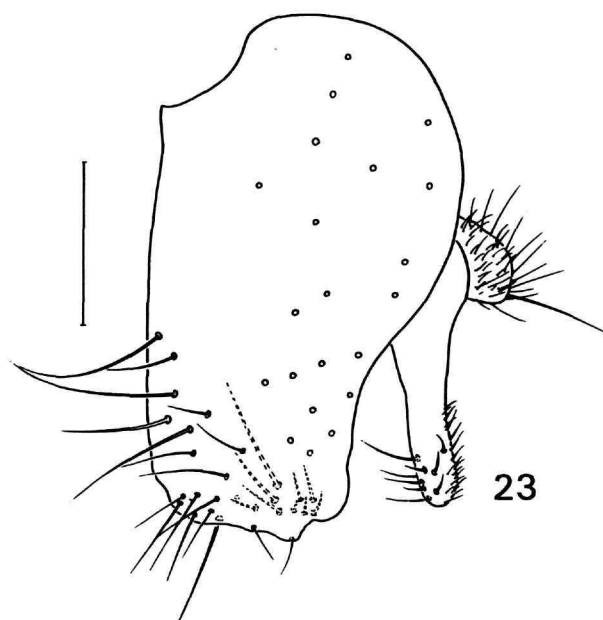

FIGURE 23.—*Pelomyia planibulla*, external male terminalia (epandrium, cercus, surstylus), lateral aspect. Scale bar = 0.1 mm.

long setae; surstylus narrower distally than basally, straight, bearing setae on distal portion; aedeagus thick, pubescent; pregonite distinct, long, tapered, pointed; hypandrium stout in lateral view; distal portion of postgonite long, tapered, pointed; basiphallus long, pointed, triangular; ejaculatory apodeme moderately flared. Female unknown.

TYPE MATERIAL.—The holotype male, the only known specimen of this species, is labeled "Pateros W[ASHINGTO]N[.] [Okanogan]: 3 Aug 1919[.] ALMelander/ALMelander Collection 1961 [green stippling on right third]/Fig [red pencil]/HOLOTYPE *Pelomyia planibulla* ♂ Foster & W.N.Mathis USNM [red label; species name and '♂ Foster &' handwritten]." The holotype is double mounted (minuten in a vertically mounted rectangular card), is in excellent condition (abdomen removed, dissected, parts in an attached microvial), and is deposited in the USNM.

DISTRIBUTION (Figure 16).—Nearctic: United States (WA).

ETYMOLOGY.—The species epithet, *planibulla*, is of Latin derivation and alludes to the rather truncate ventral lobe.

REMARKS.—We place this species in the *coronata* group because it has the peculiar hood-like, pregonite structure, and the postgonites have the nodulate flexion zone.

8. *Pelomyia dentata*, new species

FIGURES 24, 25, 30

DIAGNOSIS.—This species is distinguished from congeners by the following combination of characters: body with grayish brown microtomentum; frons yellowish orange, darker near ocellar triangle; antenna mostly brown with ventral margin and most of mesal surface of 1st flagellomere orange; fronto-orbital seta 1, reclinate; parafrenal setulae few, minute, 1 slightly larger setula between fronto-orbital seta and base of antenna; oral vibrissae minute, weak; gena approximately 0.40 times eye height; mesonotum uniformly grayish brown; upper portion of anepisternum brownish, lower with grayish microtomentum; acrostichal setulae few, minute, in 2 scattered rows; wing crossveins not infuscate; tarsomeres of normal size; forecoxa brown in base color; mid- and hindfemora not swollen, entirely gray; approximately upper 1/3 of tibiae yellowish, remainder gray; forefemoral anteroventral ctenidial comb of setae short, weak, shorter than width of foretibia.

DESCRIPTION.—Length of head and thorax 1.40 mm (abdomen removed for dissection); body generally with grayish brown microtomentum.

Head: Ocellar triangle with grayish microtomentum; frons yellowish orange, extreme margins with silvery gray microtomentum; frontal lunule yellowish; fronto-orbital seta 1; parafrenal setulae few, minute, with 1 slightly larger setula between fronto-orbital seta and base of antenna; ocellar setae 1 pair, well developed, another 2 or 3 minute, weak ocellar setu-

lae; paravertical setae short, weak, widely separated and convergent. Antennal scape and pedicel black or brown, 1st flagellomere usually yellowish on entire mesal surface, lateral surface partly to mostly brownish apically. Gena approximately 0.40 times eye height, with whitish yellow microtomentum and many minute, scattered setulae; shiny chitinous stripe along parafacial and peristomal margins; palpus yellow; clypeus gray.

Thorax: Mesonotum uniformly with grayish brown microtomentum; upper portion of anepisternum brownish, lower portion with grayish microtomentum. Wing hyaline; costal section ratios 5.8:1.5:1.2. Forecoxa brown in base color, with white microtomentum, with 2 or 3 large setae in addition to a few smaller ones; mid- and hindcoxae with grayish microtomentum; forefemur slightly swollen, with gray microtomentum and bearing row of 6–8 moderately strong setae on posterodorsal surface, posteroventral row weaker, distal 2 or 3 strongest, many scattered smaller setae on remainder of posterior surface, otherwise evenly setulose; forefemoral anteroventral ctenidial comb of setae weak, shorter than width of foretibia; hindfemur slightly swollen; mid- and hindfemora with gray microtomentum, evenly setulose, anterior surface of midfemur with 1 stronger seta in middle; approximately basal 1/3 of tibiae yellowish, remainder gray, microtomentose, evenly setulose; tarsi brown to black.

Abdomen: Male terminalia (Figures 24, 25): ventral lobe of epandrium truncate along ventral margin, with a sharp tooth-like extension directed medially from posterior ventral corner, a row of long fine setulae along medial ventral margin; outer surface of epandrium with rather short setulae; surstylus relatively short, thick, truncate to boot-shaped, densely setulose along posterior margin; aedeagus thick, pubescent; pregonite weak but widely flared posteriorly, with a few weak setulae, extended as a hood over basiphallus; hypandrium in lateral view narrow; distal portion of postgonite long, spatulate; basiphallus long, pointed, triangular; ejaculatory apodeme with a moderate flare. Female unknown.

TYPE MATERIAL.—The holotype male is labeled "ARGENT[INA]. Jujuy[:] La Quiaca[.] 23.X.68. [23 Oct 1968] 3500m.[.] L.E.Pena/HOLOTYPE *Pelomyia dentata* ♂ Foster & W.N.Mathis [red label; species name and '♂ Foster &' handwritten]." The holotype is glued directly to the pin, is in fair condition (somewhat dusty, several setae are broken and the right wing and right midleg are glued separately to the pin above the specimen) with the abdomen removed and dissected (parts in an attached microvial), and is deposited in the CNC.

OTHER SPECIMENS EXAMINED.—ARGENTINA. *Salta*: Rosário de Lerma, 24 Feb 1992, S.A. Marshall (1♂; GUE).

BOLIVIA. *Cochabamba*: Cochabamba (17°23.3'S, 65°07'W; 2610 m), 25 Mar 2001, A. Freidberg (1♂; USNM).

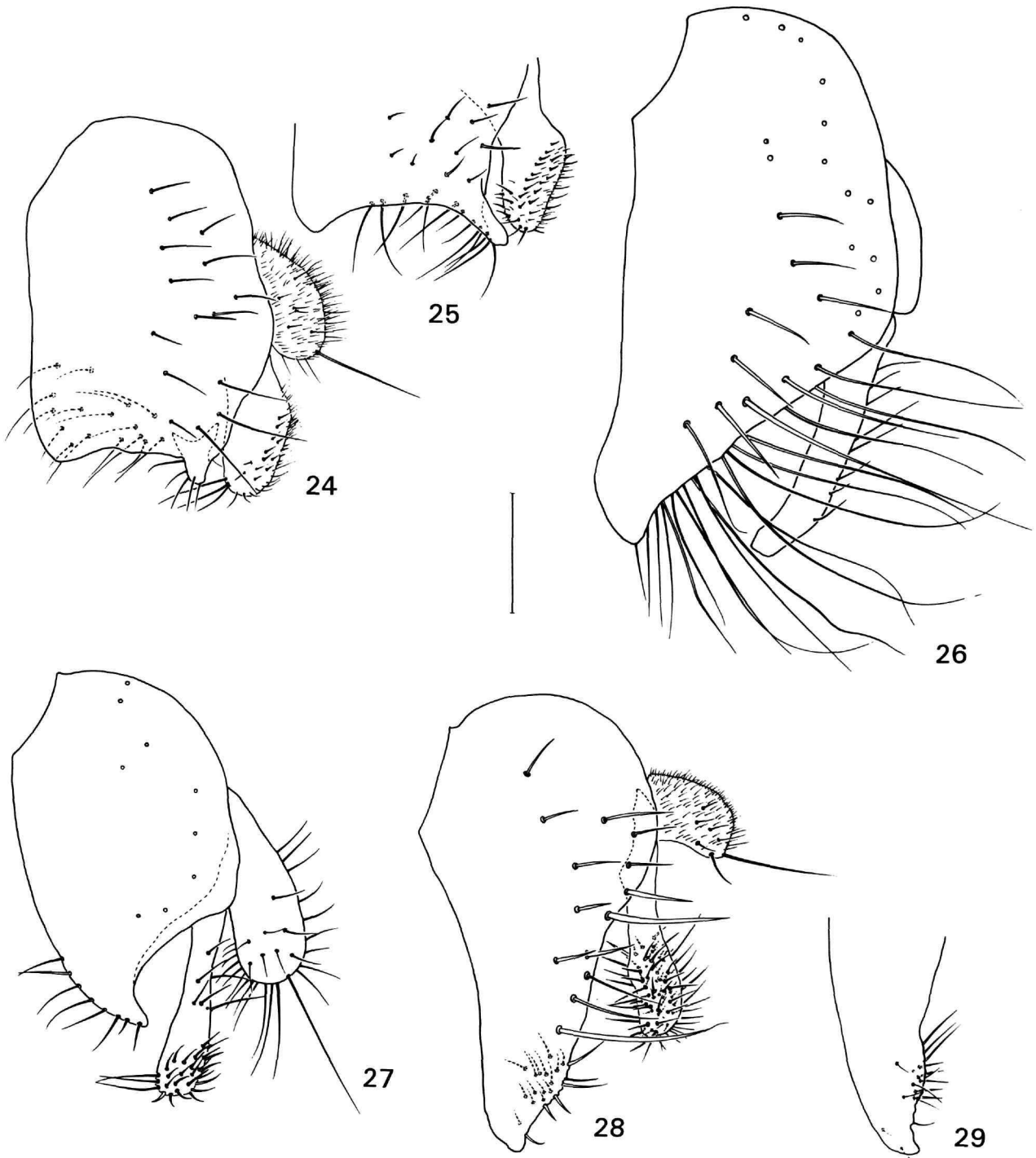

FIGURES 24–29.—External male terminalia (epandrium, cercus, surstylus): 24, *Pelomyia dentata*, lateral aspect; 25, ventral lobe of *P. dentata*, ventroblique aspect; 26, *P. aurantifrons*, lateral aspect; 27, *P. irwini*, lateral aspect; 28, *P. nigritarsis*, lateral aspect; 29, ventral lobe of *P. nigritarsis*, posteroblique aspect. Scale bar = 0.1 mm.

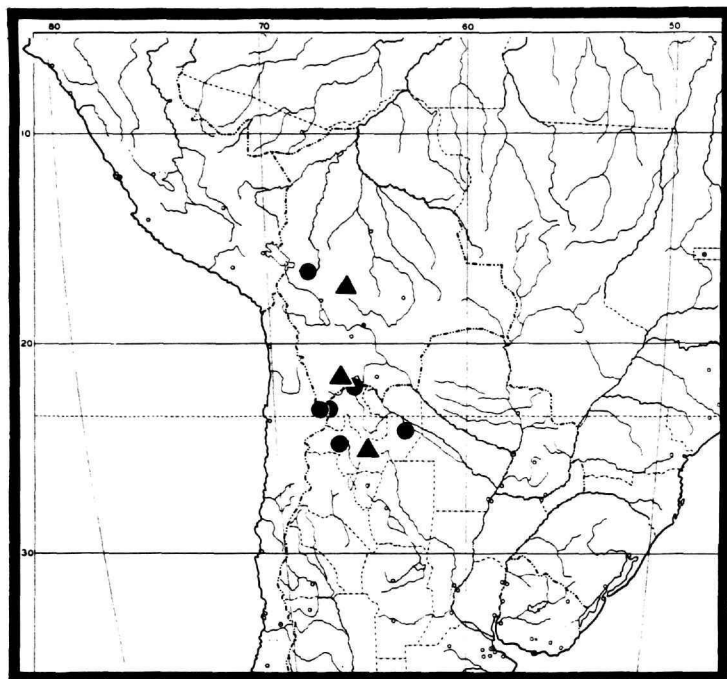

FIGURE 30.—Distribution map for *Pelomyia dentata* (triangles) and *P. nigratarsis* (dots).

DISTRIBUTION (Figure 30).—Neotropical: Argentina (Jujuy, Salta), Bolivia (Cochabamba).

ETYMOLOGY.—The species epithet, *dentata*, is of Latin derivation and refers to the tooth-like extension of the ventral lobe.

REMARKS.—This species is difficult to identify without examination of the male terminalia. The ventral lobe of the epanidium is largely undeveloped with only a small tooth-like extension on the posteroventral corner.

9. *Pelomyia aurantifrons*, new species

FIGURES 26, 31

DIAGNOSIS.—This species is distinguished from congeners by the following combination of characters: body with generally brownish microtomentum; postpronotal, notopleural, and anatergal surfaces slightly paler; frons dark orange, extreme margins with silvery microtomentum; parafrontal setae few, minute, 1 slightly larger seta near base of antenna; fronto-orbital seta 1, reclinate; antenna mostly black with distal margin and much of medial surface of 1st flagellomere orange; oral vibrissae minute, weak; gena 0.35 times eye height; acrostichal setulae minute, in 2 scattered rows; wing crossveins not infuscate; tarsomeres of normal size; forecoxa black in base color; mid- and hindfemora not swollen, entirely black; forefemoral anteroventral ctenidial comb of setae minute but numerous, shorter than width of foretibia.

DESCRIPTION.—Body length 2.35–3.25 mm; body generally with brown microtomentum.

Head: Ocellar triangle with brown microtomentum; frons dark orange, extreme margins with silvery microtomentum; frontal lunule silvery, parafrontal setulae few, minute, with 1 slightly larger near base of antenna; ocellar setae 1 pair, strong, another pair of minute ocellar setulae; paraverticlar setae minute, widely separated, and convergent. Antenna mostly black, only ventral margin of lateral and ½ of medial surface of 1st flagellomere orange. Gena 0.35 times eye height, with silvery brownish microtomentum, bearing many minute, scattered setulae; shiny chitinous stripe along parafacial and peristomal margins; palpus yellow; clypeus with silvery gray microtomentum.

Thorax: Mesonotum mostly with brownish microtomentum, with grayish microtomentum on postpronotal, notopleural, and anatergal surfaces; pleural sclerites uniformly with brown microtomentum. Wing hyaline; costal section ratios 6.7:1.5:1.0. Forecoxa black in base color, with grayish white microtomentum, with 2 or 3 large setae in addition to a few smaller ones; mid- and hindcoxae concolorous with forecoxa; forefemur moderately swollen, with black microtomentum and bearing a row of 6–8 strong setae on both posterodorsal and posteroventral surfaces, distal 2 or 3 usually strongest, many scattered smaller setae on remainder of posterior surface, otherwise evenly setulose; forefemoral anteroventral ctenidial comb of setae minute but numerous, shorter than width of foretibia; hindfemur moderately swollen; mid- and hindfemora with black microtomentum, evenly setulose with anterior surface of midfemur bearing 1 stronger seta in middle; tibiae black, evenly setulose; tarsi black.

Abdomen: Uniformly with brownish microtomentum, only extreme posterior margin of each segment paler. Male terminalia (Figure 26): ventral lobe of epandrium narrowed ventrally, anterior margin bare, posterior margin bearing many long, thick setae; surstylus spatulate, curving forward slightly, with fine setae on posterior margin; aedeagus thick, pubescent; pregonite distinct, distally shorter, broad, slightly curved; hypandrium narrow in lateral view; distal portion of postgonite widely spatulate; basiphallus long, pointed, triangular; ejaculatory apodeme moderately flared. Female terminalia: cercus often bearing some well-developed setulae.

TYPE MATERIAL.—The holotype male is labeled "PERU. Cuzco: Quis-picamchis, Huambu-tio, 2900 m, 1 Sep 1988, A.Freidberg/HOLOTYPE *Pelomyia aurantifrons* ♂ Foster & W.N.Mathis USNM [red label; species name and '♂ Foster &' handwritten]." The holotype is double mounted (minuten in a block of white plastic), is in excellent condition, and is deposited in the USNM.

Three paratypes (2♂, 1♀; USNM) bear the same label data as the holotype. Other paratypes are as follows: **ARGENTINA. Catamarca:** El Arenal (Aconquija; 2600 m), 3–4 Oct 1968, L.E. Peña (6♀; CNC). **Jujuy:** Abraite (85 km S Abra Pampa; 3650 m), 29 Oct 1968, L.E. Peña (1♀; CNC); Barrios (S La Quiaca; 3500 m), 31 Oct 1968, L.E. Peña (3♂, 1♀; CNC); Cangrejillos (S La Quiaca; 3500 m), 28 Oct 1968, L.E. Peña (1♀; CNC); Cerrillos (3600 m), 31 Oct 1968, L.E. Peña (3♂; CNC); Cieneguillas (3650 m), 28 Oct 1968, L.E. Peña (1♂, 3♀; CNC); Jujuy (2200 m), 6 Jan 1956, L.E. Peña (4♂, 3♀; CNC); Jujuy (3 km N Humahuaca; 3300 m), 22 Oct 1968, L.E. Peña (1♀; CNC); La Quiaca (3500 m), 23 Oct 1968, L.E. Peña (18♂, 16♀; CNC); Lecho (32 km E La Quiaca (3300 m), 24 Oct 1968, L.E. Peña (13♂, 28♀; CNC); Santa Catalina (3700 m), 25 Oct 1968, L.E. Peña (2♂, 1♀; CNC); Tilcara (12 km S; 2000 m), 24 Oct 1968, L.E. Peña (2♂, 2♀; CNC).

BOLIVIA. Cochabamba: Cochabamba (17°23.3'S, 65°07'W; 2610 m), 25 Mar 2001, A. Freidberg (1♀; USNM); Leque Palca (1 km E; 17°37.7'S, 66°57'W; 3970 m), 26 Mar 2001, A. Freidberg (1♀; USNM); Leque Palca (2 km W; 17°37.7'S, 67°57'W; 3970 m), 23 Mar 2001, W.N. Mathis (1♂; USNM). **La Paz:** El Alto (14 km S; 16°40.1'S, 68°11'W; 3900 m), 20 Mar 2001, A. Freidberg (1♂, 3♀; USNM); El Alto (23 km S; 16°42.7'S, 68°11.2'W; 3860 m), 21 Mar 2001, A. Freidberg (1♀; USNM); Patacamya (7 km NE; 17°7.5'S, 67°56.7'W; 3800 m), 21 Mar 2001, A. Freidberg, W.N. Mathis (16♂, 10♀; USNM). **Oruro:** Caracollo, 21 Mar 2001, A. Freidberg (1♂, 3♀; USNM); Challapata (45 km S; 19°12.9'S, 66°47.7'W; 3690 m), 22 Mar 2001, A. Freidberg (2♀; USNM); Pazña (S of town; 18°36.2'S, 66°54.7'W; 3750 m), 22 Mar 2001, A. Freidberg (2♂, 2♀; USNM).

CHILE. Coquimbo: Socos, 2 Nov 1957, L.E. Peña (1♂; CNC).

PERU. Cuzco: Quispicanchis, Huarcapay (2900 m), 1 Sep 1988, W.N. Mathis (9♂, 4♀; USNM); Paucartambo (13°18'S, 71°40'W; 2900 m), 2 Sep 1988, W.N. Mathis (3♂; USNM). **Huánuco:** Huánuco, 16 Sep 1954, E.S. Ross, E.I.

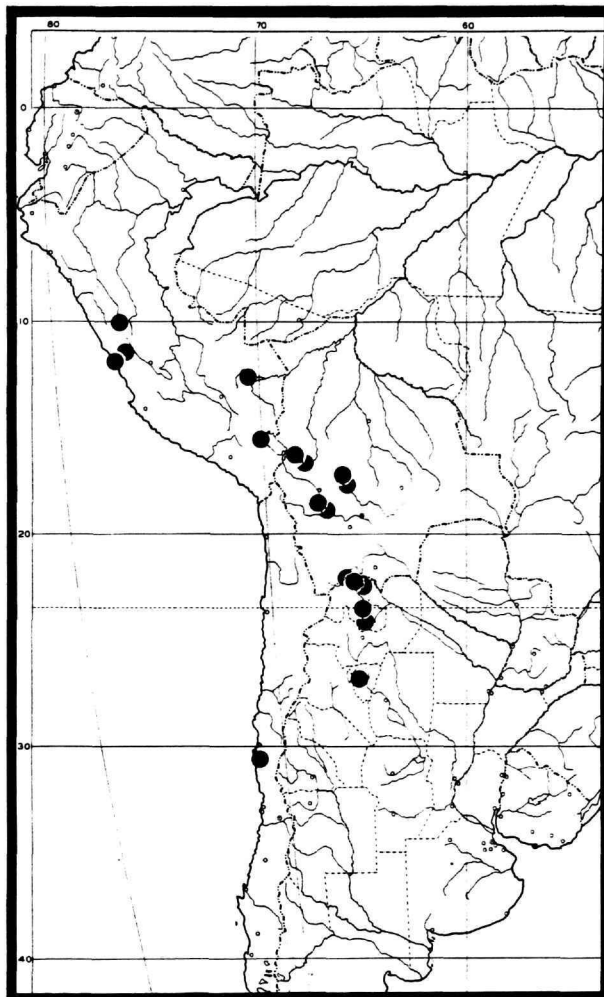

FIGURE 31.—Distribution map for *Pelomyia aurantifrons*.

Schlinger (1♀; CAS). **Junin:** Tarma (10,000 ft), 13 Jul 1928, R.C. Shannon (1♀; USNM). **Lima:** Belen Station (railroad station), 4 Mar 1953, J.A. Munro (1♀; USNM). **Puno:** La Huerta, 24–28 Nov 1955, L.E. Peña (1♀; CNC); Pusi, 18–23 Oct 1965, J.C. Hitchcock, Jr. (27♂, 17♀; USNM).

DISTRIBUTION (Figure 31).—Neotropical: Argentina (Catamarca, Jujuy), Bolivia (Cochabamba, La Paz, Oruro), Chile (Coquimbo), Peru (Cuzco, Huánuco, Junín, Lima, Puno).

ETYMOLOGY.—The species epithet, *aurantifrons*, is of Latin derivation and alludes to the orange-colored frons.

REMARKS.—This species clearly belongs in the *coronata* group, having the hood-like, pregonite extensions over the long, pointed, triangular basiphallus. The pregonites of this species are reduced to thin, ventral sclerites, but they are expanded dorsally into the hood and posteriorly into wide spatulate lobes as in other species of this subgenus.

10. *Pelomyia irwini*, new species

FIGURES 27, 32

DIAGNOSIS.—This species is distinguished from congeners by the following combination of characters: body with grayish brown microtomentum; frons orange, few minute scattered setulae; parafrontal setae present as several minute hairs; fronto-orbital seta 1, reclinate; antenna mostly black, medial surface of 1st flagellomere partly orange; oral vibrissae minute, weak; gena 0.28 times eye height; acrostichal setulae minute, in 2 scattered rows; wing crossveins not infusate; tarsomeres of normal size; forecoxa black in base color, silvery white microtomentum; mid- and hindfemora not swollen, black; forefemoral anteroventral ctenidial comb of setae weak, shorter than width of foretibia.

DESCRIPTION.—Body length 1.95–3.25 mm; body generally with grayish brown microtomentum.

Head: Ocellar triangle with gray microtomentum, ocellar setae 1 pair, strong, black; another pair of minute ocellar setulae; paravertical setae minute, widely separated, convergent; frons yellowish orange with a few minute setulae; frontal lunule with silvery microtomentum; parafrons with silvery microtomentum; parafrontal setulae few, minute, with 1 slightly larger near base of antenna. Antenna mostly black, only ventral margin of lateral and $\frac{1}{2}$ of medial surface orange. Gena 0.28 times eye height; with whitish gray to tan microtomentum, with minute scattered setulae; shiny chitinous parafacial and peristomal stripe; palpus yellow; clypeus gray.

Thorax: Mesonotum with gray to brownish microtomentum; pleural sclerites with gray microtomentum and distinct band of brown microtomentum on dorsal $\frac{1}{2}$ of anepisternum; acrostichal setulae few, minute, in 2 uneven rows. Wing hyaline; costal section ratios 7.0:2.0:1.0. Forecoxa black in base color, with whitish gray microtomentum, with 2 or 3 large setae in addition to a few smaller ones; mid- and hindcoxae concolorous with forecoxa; forefemur strongly swollen, with black microtomentum and bearing a row of 6–8 strong setae on both posterodorsal and posteroventral surfaces, distal 2 or 3 usually the longest, many scattered smaller setae on remainder of posterior surface, otherwise evenly setulose; forefemoral anteroventral ctenidial comb of setae weak, shorter than width of foretibia; hindfemur moderately swollen; mid- and hindfemora with black microtomentum, evenly setulose with anterior surface of midfemur bearing 1 stronger seta in middle; tibiae with black microtomentum, evenly setulose; tarsi black.

Abdomen: With grayish brown microtomentum, extreme posterior margin of each segment slightly paler. Male terminalia (Figure 27): ventral lobe of epandrium narrowed ventrally into an acute recurved point, anterior margin with a few moderate setae, posterior margin bare; surstylus club-shaped, armed distally with many short setae and medially with only a few setae; aedeagus thick, pubescent; pregonite distinct, long, tapered, pointed, partially fused to postgonite; hypandrium in lateral view narrow; distal portion of postgonite long, tapered,

pointed; basiphallus long, pointed, triangular; cercus widely spatulate; ejaculatory apodeme with small flare. Female terminalia: cercus with fine hairs only.

TYPE MATERIAL.—The holotype male is labeled "PERU. Huanuco: Huanuco (10km N) Rio Huallaga[,] 4 February 1984[,] Wayne N Mathis/HOLOTYPE *Pelomyia irwini* ♂ Foster & W.N.Mathis USNM [red label; species name and '♂ Foster &' handwritten]." The holotype is double mounted (mounted in a block of red plastic), is in excellent condition, and is deposited in the USNM.

Twenty-one paratypes (13♂, 8♀; USNM) bear the same label data as the holotype. Other paratypes are as follows: ARGENTINA. *Jujuy*: Coyaquayma (7 km S Mina Perquitas; 4100 m), 4 Nov 1968, L.E. Peña (2♂; CNC); Rio Cincel (S end Lago Pozuelos; 3800 m), 3 Nov 1968, L.E. Peña (1♀; CNC);

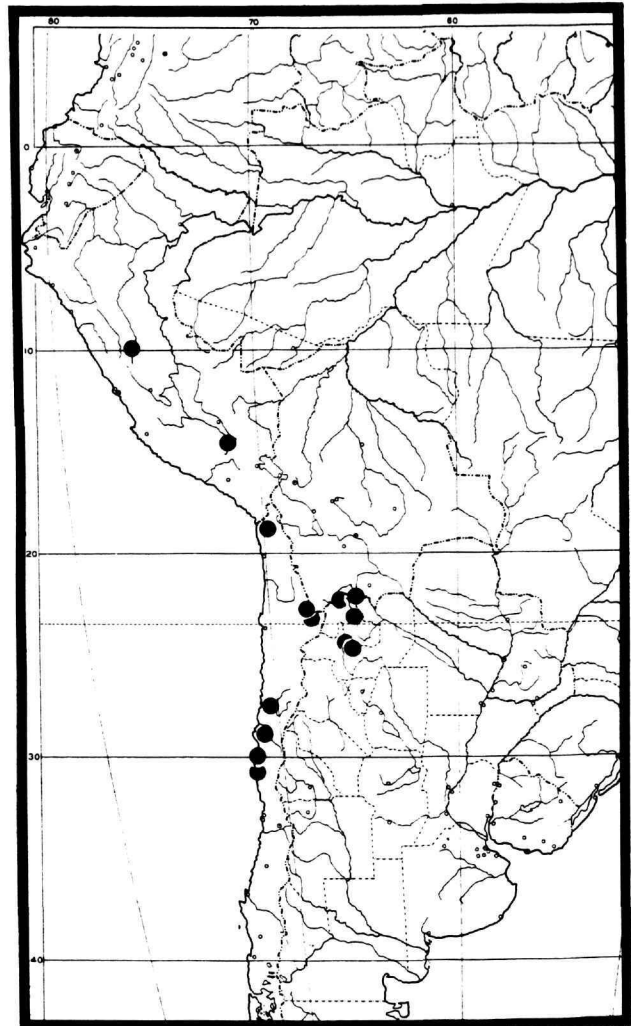

FIGURE 32.—Distribution map for *Pelomyia irwini*.

Tres Cruces (lakeside; 3700 m), 26 Feb 1992, S.A. Marshall (1♀; GUE). *Salta*: Los Colorados (35 km S Pocitos; 3600 m), 7 Nov 1968, L.E. Peña (6♀; CNC); Rosário de Lerma, 24 Feb 1992, S.A. Marshall (1♀; GUE); Santa Rosa de Tastil, 26 Feb 1992, S.A. Marshall (1♀; GUE).

CHILE. *Antofagasta*: Puripicar (SE Quisquiro Salt Lake; 4000–4200 m), 9–12 Dec 1965, L.E. Peña (1♂; CNC); San Pedro de Atacama (2280 m), 1–5 May 1964, L.E. Peña (7♂, 2♀; CNC). *Atacama*: Copiapo (540 m), Nantoco, 19 Sep 1952, P.G. Kuschel (3♂, 3♀; USNM); Vallenar, El Portillo, 23 Sep 1952, P.G. Kuschel (1♂; USNM); Vallenar, 18 Sep 1952, P.G. Kuschel (1♂; USNM); Atacama, 21 Oct 1957, L.E. Peña (10♂, 6♀; CNC). *Coquimbo*: Incahuasi, 30 Sep 1952, P.G. Kuschel (2♀; USNM); Ovalle (70 mi S; coast road), 13 Dec 1950, E.S. Ross, A.E. Michelbacher (1♂; CAS). *Tarapaca*: Camarones, 5–6 Nov 1955, L.E. Peña (8♂, 22♀; CNC); Chaca, 6–7 Nov 1955, L.E. Peña (14♂, 18♀; CNC).

PERU. *Cuzco*: Quispicanchis, Huambutio (2900 m), 1 Sep 1988, W.N. Mathis (2♂, 2♀; USNM). *Huánuco*: Espensa, (11 km N Huánuco), 5 Feb 1984, W.N. Mathis (5♂, 1♀; USNM).

DISTRIBUTION (Figure 32).—Neotropical: Argentina (Jujuy, Salta), Chile (Antofagasta, Atacama, Coquimbo, Tarapaca), Peru (Cuzco, Huánuco).

ETYMOLOGY.—The species epithet, *irwini*, is a genitive patronym to recognize and honor the contributions of A.G. Irwin, Norwich Museum, Norwich, England.

11. *Pelomyia nigratarsis*, new species

FIGURES 28–30

DIAGNOSIS.—This species is distinguished from congeners by the following combination of characters: body with brownish gray microtomentum; frons yellowish orange, darker near ocellar triangle; antenna mostly black with apical part of mesal surface of 1st flagellomere faintly orange; fronto-orbital seta 1, reclinate; parafacial setulae few, minute; oral vibrissae tiny, weak or absent; gena approximately 0.35–0.40 times eye height; mesonotum uniformly brownish gray, anepisternum and anepimeron mostly brown, lower portion with gray microtomentum; acrostichal setulae few, minute, in 2 scattered rows; wing crossveins not infusate; tarsomeres of normal size; forecoxa black or brown in base color, covered with silvery gray microtomentum; mid- and hindfemora not swollen, entirely black; tibiae black; forefemoral anteroventral ctenidial comb of setae short, weak, shorter than width of foretibia.

DESCRIPTION.—Body length 2.1–3.0 mm; body generally with brown to brownish gray microtomentum.

Head: Ocellar triangle with grayish microtomentum; frons yellowish orange, extreme margins with silvery gray microtomentum; frontal lunule white; parafacial setulae few, minute, with 1 slightly larger seta near base of antenna; ocellar seta 1, well developed, another 2 or 3 minute ocellar setulae; parafacial setae short, weak, widely separated and convergent. An-

tenna mostly black, with part of mesal surface of 1st flagellomere faintly orange apically. Gena approximately 0.35–0.40 times eye height, with yellowish white microtomentum and many minute, scattered setulae; shiny chitinous stripe along parafacial and peristomal margins; palpus yellow; clypeus gray.

Thorax: Mesonotum uniformly brownish gray, anepisternum and anepimeron mostly brown, lower portion with gray microtomentum. Wing hyaline; costal section ratios 5.3:1.3:1.0. Forecoxa black or brown in base color, with silvery gray microtomentum, with 2 or 3 large setae in addition to a few smaller ones; mid- and hindcoxae gray, microtomentose; forefemur moderately swollen, with gray microtomentum and bearing a row of 6–8 strong setae on posterodorsal surface, posteroventral row weaker except for distal 2 or 3 setae, many scattered smaller setae on remainder of posterior surface, otherwise evenly setulose; forefemoral anteroventral ctenidial comb of setae weak, shorter than width of foretibia; hindfemur moderately swollen; mid- and hindfemora with black microtomentum, evenly setulose, anterior surface of midfemur with 1 stronger seta in middle; tibiae with black microtomentum, evenly setulose; tarsi black.

Abdomen: With grayish to brownish microtomentum, extreme posterior margin of each tergite yellow. Male terminalia (Figures 28, 29): ventral lobe of epandrium triangular, narrowed ventrally to a point, anterior margin bare, posterior margin with a cluster of many short setae on median surface; surstylus relatively long, spatulate, curved medially, densely setulose distally; aedeagus thick, pubescent; pregonite distinct, widely flared posteriorly, partly fused with postgonite, setulose dorsally, extended as a hood over basiphallus; hypandrium in lateral view narrow; distal portion of postgonite long, spatulate; basiphallus long, pointed, triangular; ejaculatory apodeme with a small flare. Female terminalia: cercus with fine hairs and some stronger setulae.

TYPE MATERIAL.—The holotype male is labeled “ARGENTINA [INA]. Jujuy[:] La Quiaca[,] 23.X.68. [23 Oct 1968] 3500m.[] L.E.Pena/HOLOTYPE *Pelomyia nigratarsis* ♂ Foster & W.N.Mathis [red label; species name and ‘♂ Foster &’ handwritten].” The holotype is glued directly to the pin, is in excellent condition, and is deposited in the CNC.

Six paratypes (5♂, 1♀; CNC) bear the same label data as the holotype. Other paratypes are as follows: ARGENTINA. *Salta*: Los Colorados (35 km S Pocitos; 3600 m), 7 Nov 1968, L.E. Peña (5♂, 1♀; CNC, USNM); Palo Pintado (N San Carlos; 1900 m), 6 Oct 1968, L.E. Peña (2♂; CNC).

BOLIVIA. *La Paz*: Patacamya (7 km NE; 17°7.5'S, 67°56.7'W; 3800 m), 21 Mar 2001, W.N. Mathis (1♂, 1♀; USNM).

CHILE. *Antofagasta*: Mucar (23°20'S; on Argentina border; 4000–4100 m), 12–16 Dec 1965, L.E. Peña (1♂; CNC); Tumbre (E Atacama Salt Lake; 3600–3800 m), 6–9 Dec 1965, L.E. Peña (20♂, 16♀; CNC, USNM); Talabre, 3600 m, 10–12 Nov 1968, L.E. Peña (4♂, 2♀; CNC).

DISTRIBUTION (Figure 30).—Neotropical: Argentina (Jujuy, Salta), Bolivia (La Paz), Chile (Antofagasta).

ETYMOLOGY.—The species epithet, *nigritarsis*, is of Latin derivation and refers to the dark tarsi.

12. *Pelomyia peruviana* Malloch

FIGURES 7, 33–36

Pelomyia peruviana Malloch, 1934:458.—Hennig, 1937:140 [citation]; 1939:82 [figure of male terminalia].—Foster, 1976b:2 [Neotropical catalog].—Mathis and Munari, 1996:9 [world catalog].

DIAGNOSIS.—This species is distinguished from congeners by the following combination of characters: body length 1.95–3.10 mm; body with mostly brown microtomentum, silvery microtomentum on postpronotum, notopleuron, supra-alar area, and anatergite; frons reddish orange with several minute setulae; parafrontal setae present as several minute hairs; fronto-orbital seta 1, reclinate; antenna black with medial surface of 1st flagellomere reddish orange; oral vibrissae short, of moderate strength for a *Pelomyia*; gena approximately 0.33–0.36 times eye height; acrostichal setulae minute, scattered; wing crossveins not infuscate; tarsomeres of normal size; fore-

coxa black or dark brown in base color, covered with silver or white microtomentum; mid- and hindfemora not swollen, black; forefemoral anteroventral ctenidial comb of setae strong, thick, longer or as long as width of foretibia (Figure 35).

DESCRIPTION.—Body length 1.95–3.10 mm; body mostly with brown microtomentum.

Head (Figure 33): Ocellar triangle with gray microtomentum; 1 ocellar seta, well developed, several other minute ocellar setulae; paravertical setae short, weak, widely separated, convergent; frons reddish orange, generally with several minute setulae; frontal lunule with white microtomentum; parafrons with silvery white microtomentum; parafrontal setulae few, minute, with 1 slightly stronger pair near base of antenna. Antenna mostly black, with distal and medial surface of 1st flagellomere reddish orange. Gena approximately 0.33–0.36 times eye height, with yellowish white microtomentum and bearing many minute, scattered setulae; shiny chitinous stripe along parafacial and peristomal margins; palpus yellow; clypeus gray.

Thorax: Mesonotum with evenly brownish microtomentum, becoming pale gray anteriorly and on notopleuron and postpronotum; pleural sclerites mostly with brown microto-

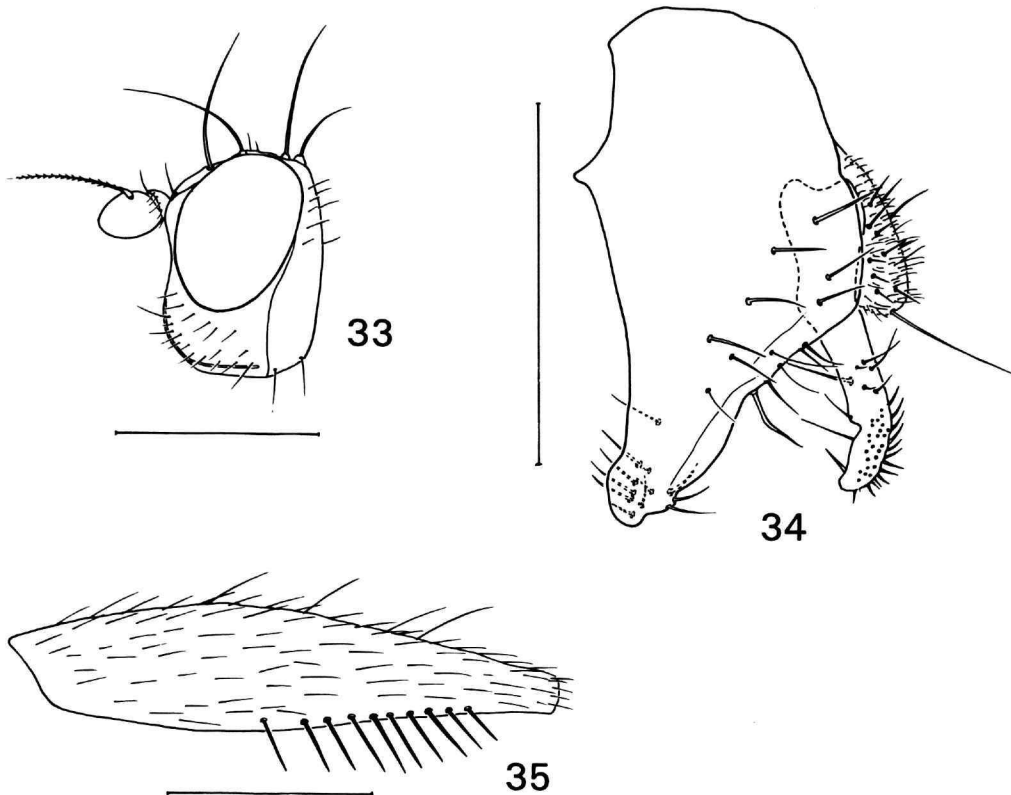

FIGURES 33–35.—*Pelomyia peruviana*: 33, head, lateral aspect; 34, external male terminalia, lateral aspect; 35, left forefemur, anterior aspect. Scale bars = 0.3 mm.

mentum; acrostichal setulae minute, in 2 scattered rows. Wing hyaline; costal section ratios 6.3:1.9:1.0. Forecoxa black in base color, with silvery to whitish microtomentum, with 2 or 3 large setae in addition to a few smaller ones; mid- and hindcoxae concolorous with forecoxa; forefemur (Figure 35) distinctly swollen, shiny black with a row of 6–8 quite strong setae on both posterodorsal and posteroventral surfaces, distal 2 or 3 usually longest, many scattered smaller setae on remainder of posterior surface, otherwise evenly setulose; forefemoral anteroventral ctenidial comb of setae consisting of many strong, thick setae, longer than narrowest width of foretibia; hindfemur barely swollen in male, female not swollen; mid- and hindfemora black subshiny, evenly setulose with anterior surface of midfemur bearing 1 stronger seta in middle; tibiae black, subshiny, evenly setulose; tarsi black.

Abdomen: Each tergite with brown microtomentum dorsally, paler brown to gray laterally and ventrally, extreme posterior margins yellowish. Male terminalia (Figure 34): ventral lobe of epandrium narrowed ventrally into a rounded point, anterior margin bare, posterior margin with a few setae, medial surface with a few moderate setae, surstylus curved forward distally, with many short, sharp setae; aedeagus thick, pubescent; pregonite distinct, long, tapered, pointed, partially fused with postgonite; hypandrium in lateral view narrow; distal portion of postgonite long, tapered, pointed; basiphallus long, pointed, triangular. Female terminalia: cercus bearing setulae only, lacking short, stout spines.

TYPE MATERIAL.—The holotype female is labeled “Peru H A Parish [handwritten]/Collection J M Aldrich/Type No. 50449 U.S.N.M. [red label; type number handwritten]/*Pelomyia peruviana* Type det. JRMALLOCH [species name and ‘Type’ handwritten].” The holotype is directly pinned, is in fair condition (several setae missing or misoriented, left foreleg mostly missing), and is deposited in the USNM.

OTHER SPECIMENS EXAMINED.—CHILE. *Antofagasta*: San Pedro de Atacama (2280 m), 1–5 May 1964, L.E. Peña (5♂, 5♀; CNC); Talabre, 3 Jun–28 Nov 1952–1960, L.E. Peña (7♂, 6♀; CNC); Talabre (3600 m), 10–12 Nov 1968, L.E. Peña (29♂, 40♀; CNC); Tumbre (E of Atacama Salt Lake; 3600–3800 m), 6–9 Dec 1965, L.E. Peña (5♂, 11♀; CNC); Tumbre, 4 Oct 1955, L.E. Peña (1♂, 3♀; CNC). *Tarapaca*: Azapa, 8–10 Nov 1955, L.E. Peña (27♂, 12♀; CNC); Chaca, 6–7 Nov 1955, L.E. Peña (7♂, 12♀; CNC); Camarones, 5–6 Nov 1955, L.E. Peña (3♂, 3♀; CNC).

ECUADOR. *Pichincha*: Guayllabamba (1850 m), 7 Jun 1965, L.E. Peña (1♂; CNC); Napo-Pastaza, Pambay, J.R. Levi-Castillo (1♂; USNM).

PERU. *Ayacucho*: Pirua (14°48'S, 73°51'W; cage, cotton buds), 20 Oct 1941, P.A. Berry (1♀; USNM). *Lima*: Lima, 30 Jul 1914, H.A. Parish (3♂; USNM); Lima, Laguna de Villa, 30 Aug 1988, W.N. Mathis (1♂, 3♀; USNM). *Moquegua*: Yacango (17°06'S, 70°52'W), 5–11 Oct 1965, J.C. Hitchcock, Jr. (24♂, 24♀; USNM). Peru, H.A. Parish, (1♂, paratype 50449; USNM).

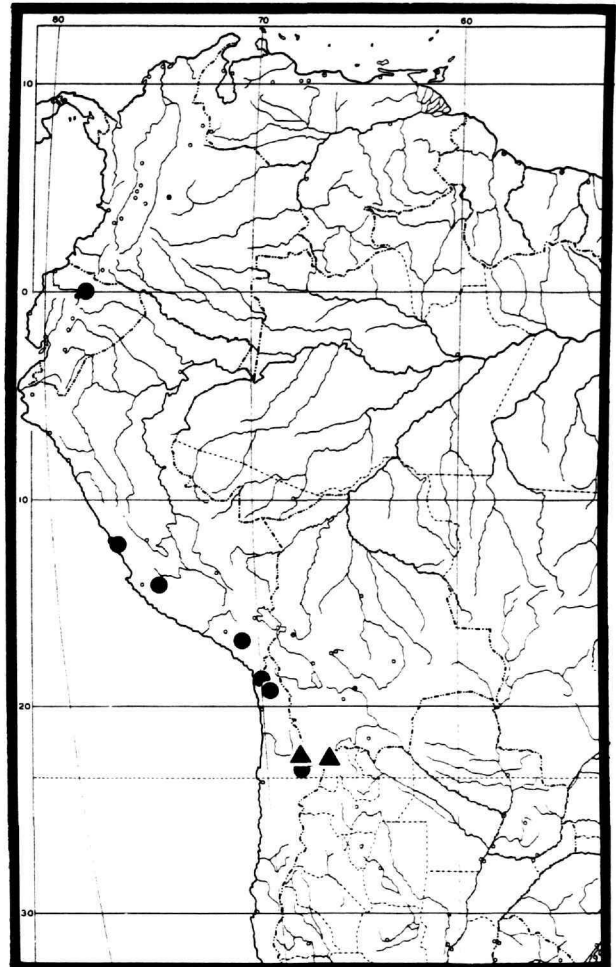

FIGURE 36.—Distribution map for *Pelomyia peruviana* (dots) and *P. robustiseta* (triangles).

DISTRIBUTION (Figure 36).—Neotropical: Chile (Antofagasta, Tarapaca), Ecuador (Pichincha), Peru (Ayacucho, Lima, Moquegua).

REMARKS.—Specimens of *P. peruviana* are easily recognized by the strongly swollen forefemora, which are shiny black and bear an unusually well-developed anteroventral ctenidial comb of setae (Figure 35).

13. *Pelomyia robustiseta*, new species

FIGURES 36, 37

DIAGNOSIS.—This species is distinguished from congeners by the following combination of characters: body entirely with gray microtomentum; frons yellowish, darker near ocellar triangle; antenna entirely black; fronto-orbital seta 1, reclinate; parafrenal setulae few, minute, 1 slightly larger seta near base of antenna; oral vibrissae minute, weak; gena approximately

0.36 times eye height; mesonotum and lateral sclerites uniformly gray; acrostichal setulae few, minute, in 2 scattered rows; wing crossveins not infuscate; tarsomeres of normal size; forecoxae black in base color; mid- and hindfemora not swollen, entirely gray; tibiae gray; setae of anteroventral comb short, weak, shorter than width of foretibia.

DESCRIPTION.—Body length approximately 2.3 mm (only head and thorax can be measured); body entirely with gray microtomentum.

Head: Ocellar triangle with grayish microtomentum; frons yellowish orange, extreme margins with silvery gray microtomentum; frontal lunule white; fronto-orbital seta 1; parafrenal setulae few, minute, with 1 slightly larger near base of antenna; ocellar seta 1, well developed, another 2 or 3 minute ocellar setulae; paraverticilar setae short, weak, widely separated and convergent. Antenna entirely black. Gena approximately 0.36 times eye height, with white microtomentum and many minute, scattered setulae; shiny chitinous stripe along parafacial and peristomal margins; palpus yellow; clypeus gray.

Thorax: Mesonotum and lateral sclerites uniformly with gray microtomentum. Wing hyaline; costal section ratios 7.0:2.0:1.0. Forecoxa black in base color, with white microtomentum, with 2 or 3 large setae in addition to a few smaller ones; mid- and hindcoxae mostly with black microtomentum; forefemur moderately swollen, with gray microtomentum and bearing a row of 6–8 strong setae on both posterodorsal and posteroventral surfaces, distal 2 or 3 strongest, many scattered smaller setae on remainder of posterior surface, otherwise evenly setulose; forefemoral anteroventral ctenidial comb of setae weak, shorter than width of foretibia; hindfemur barely swollen; mid- and hindfemora with gray microtomentum, evenly setulose, anterior surface of midfemur with one stronger seta in middle; tibiae gray, microtomentose, evenly setulose; tarsi gray.

Abdomen: With gray microtomentum. Male terminalia (Figure 37): epandrium with many short stout setae; ventral lobe of epandrium quite long and rather straight, triangular, narrowed ventrally to a point, anterior margin bare, ventral mesal surface with several short, weak setae; surstylus relatively long, curved slightly anteriorly, densely setulose with some very short peg-like setae as well as some longer thinner ones; aedeagus thick, pubescent; pregonites reduced, not evident; hypandrium in lateral view narrow; distal portion of postgonite long, rod-like; basiphallus long, pointed, triangular; ejaculatory apodeme moderately flared. Female unknown.

TYPE MATERIAL.—The holotype male is labeled "ARG[ENTINA]. Juj[uy]. 4100m.[.] Coyaquayma. 7km. S. Mina Perquitas 4.XI.68.[4 Nov 1968,] [L.E.]Pena/HOLOTYPIC Pelomyia robustiseta ♂ Foster & W.N.Mathis [red label; species name and '♂ Foster &' handwritten]." The holotype is glued directly to the pin, is in fair condition (somewhat flattened in the pinning process, dusty, several setae are broken or missing and the right middle tarsal segments are missing) with the abdomen re-

moved and dissected (parts in an attached microvial), and is deposited in the CNC.

Paratypes are as follows: ARGENTINA. *Jujuy*: Tres Cruces (lakeside; 3700 m), 26 Feb 1992, S.A. Marshall (1♂; GUE).

CHILE. *Antofagasta*: Mucar (on Argentina border, 23°20'S; 4000–4100 m), 12–16 Dec 1965, L.E. Peña (1♂; CNC).

DISTRIBUTION (Figure 36).—Neotropical: Argentina (*Jujuy*), Chile (*Antofagasta*).

ETYMOLOGY.—The species epithet, *robustiseta*, is of Latin derivation and refers to the well-developed setae on the epandrium and surstylus.

REMARKS.—This species is similar to and appears to be related to *P. coronata*, *P. nubila*, and other species of the *coronata* group having the postgonites long and rod-like. It differs in not having the pregonites protracted into a long distal lobe. The pregonites of this species appear to be reduced compared with many other species in this group.

With only two allopatric males (the holotype being one), we were reluctant to dissect fully the internal copulatory apparatus, so some data are lacking or unavailable for this species.

14. *Pelomyia trivittata* Malloch

FIGURES 38, 43

Pelomyia trivittata Malloch, 1934:459.—Hennig, 1937:140 [citation].—Foster, 1976b:2 [Neotropical catalog].—Mathis and Munari, 1996:9 [world catalog].

DIAGNOSIS.—This species is distinguished from congeners by the following combination of characters: body length 1.85–2.70 mm; body with brownish gray microtomentum; postpronotum, notopleuron, and anatergite with dull silvery gray microtomentum; frons yellowish orange; parafrons silvery gray; fronto-orbital seta 1, reclinate; parafrenal setae present as several minute hairs; antenna mostly black, only medial surface of 1st flagellomere dark orange; oral vibrissae minute, weak; gena approximately 0.35–0.40 times eye height; acrostichal setulae minute, in 2 scattered rows; dorsocentral track with paler gray band; wing crossveins not infuscate; tarsomeres of normal size; forecoxa black in base color, covered with silvery white microtomentum; mid- and hindfemora not swollen, dark gray; forefemoral anteroventral ctenidial comb of setae weak, shorter than width of foretibia.

DESCRIPTION.—Body length 1.85–2.70 mm; body with grayish to brownish microtomentum.

Head: Ocellar triangle with brown microtomentum; ocellar setae 1 pair, moderately strong, several other minute ocellar setulae; paraverticilar setae minute, not widely separated, convergent; frons yellowish orange, generally with several minute setulae; frontal lunule with whitish microtomentum; parafrons with silvery white microtomentum; parafrenal setulae few, minute, with 1 slightly stronger pair near base of antenna. Antenna mostly black, only medial surface of flagellomere dark orange. Gena approximately 0.35–0.40 times eye height, with yellowish white microtomentum and bearing

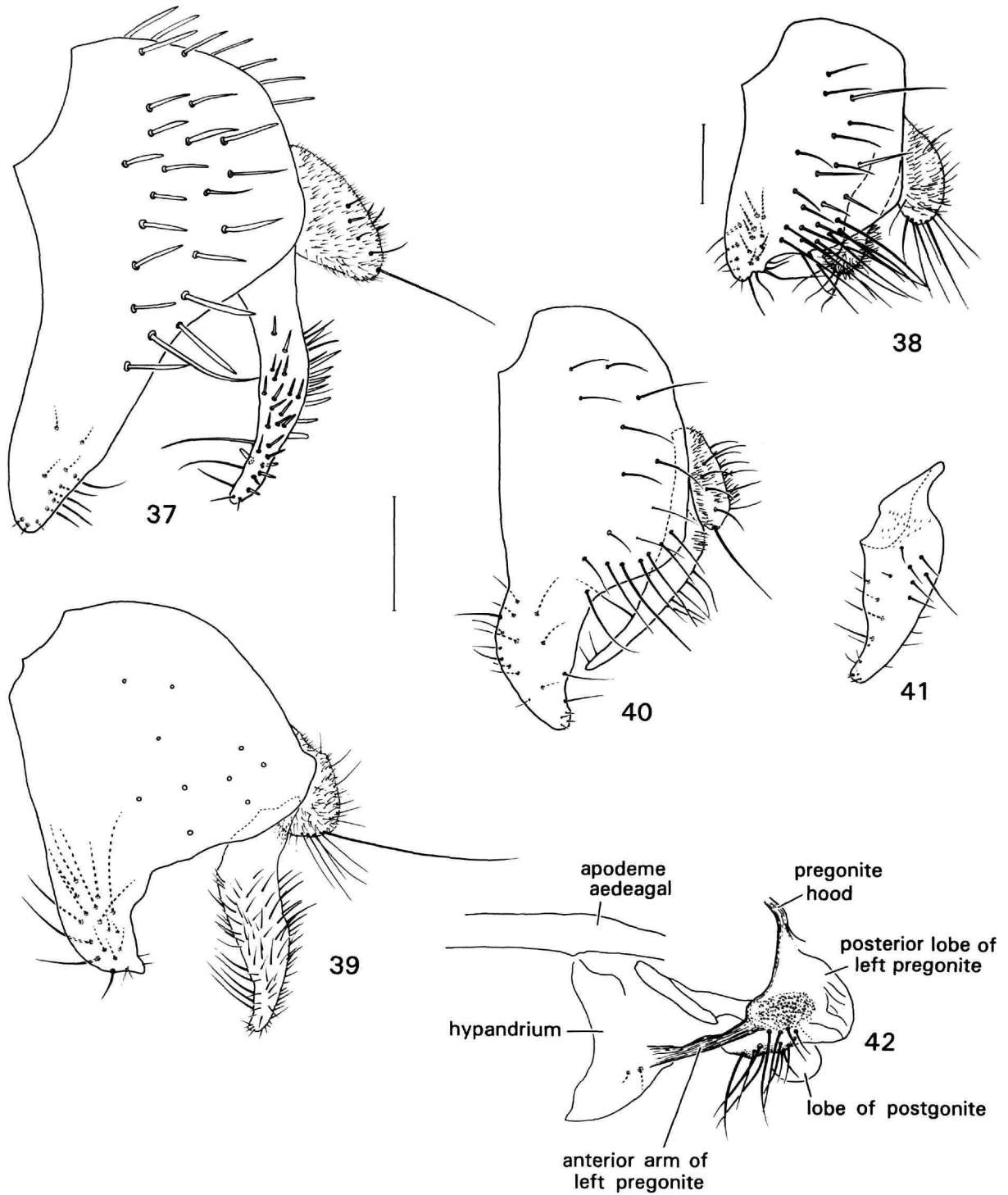

FIGURES 37-42.—External male terminalia (epandrium, cercus, surstylus): 37, *Pelomyia robustiseta*, lateral aspect; 38, *P. trivittata* Malloch, lateral aspect; 39, *P. viedmae* Malloch, lateral aspect; 40, *P. vockerothi*, lateral aspect; 41, right ventral lobe of *P. vockerothi*, posterior aspect; 42, internal copulatory apparatus of *P. vockerothi*, lateral aspect. Scale bars = 0.1 mm (scale bar to left of Figure 38 applies only to that figure).

many minute, scattered setulae; shiny chitinous stripe along parafacial and peristomal margins; palpus yellow; clypeus gray.

Thorax: Mesonotum with brownish microtomentum, paler gray bands present along dorsocentral setae, extended onto scutellum; notopleuron and postpronotum also with paler gray microtomentum; pleural sclerites mostly pale gray with small dorsal portion of anepisternum pale brown; acrostichal setulae minute, in 2 scattered rows. Wing hyaline; costal section ratios 5.9:1.6:1.0. Forecoxa black in base color, covered with gray microtomentum, with 2 or 3 large setae in addition to a few smaller ones; mid- and hindcoxae gray; forefemur moderately swollen, with gray microtomentum and bearing a row of 6–8 strong setae on both posterodorsal and posteroventral surfaces, distal 2 or 3 sometimes longest, many scattered smaller setae on remainder of posterior surface, anteroventral ctenidial comb of setae weak, shorter than width of foretibia; hindfemur barely swollen; remainder of mid- and hindfemora, tibiae, and tarsi with gray to black microtomentum and evenly setulose with anterior surface of midfemur bearing 1 stronger seta in middle.

Abdomen: Each tergite with brown microtomentum anteriorly, becoming gray posteriorly, extreme posterior margins yellowish, laterally grayish. Male terminalia (Figure 38): ventral lobe of epandrium narrowed gradually, broadly triangulate, anterior margin bare, posterior margin with a few stout setae near apex, medial surface with a number of stout setae, a patch of long posteriorly directed setae on medial surface of ventral lobe; surstylus sharply curved anteriorly at apex, bearing many fine setulae and several long setae; aedeagus thick, pubescent; pregonite distinct, broadly tapered, pointed; hypandrium in lateral view narrow; distal portion of postgonite long, tapered, pointed; basiphallus long, pointed, triangular. Female terminalia: cercus bearing short, stout spines.

TYPE MATERIAL.—The holotype male of *Pelomyia trivittata* is labeled “Renaico Chile Apr.1.1932 DSBullock/Type No. 50450 U.S.N.M. [red label; number handwritten]/*Pelomyia trivittata* Type det. JRMALLOCH [species name and ‘Type’ handwritten]. The holotype is double mounted (glued to a paper point), is in good condition (some setae broken or missing), and is deposited in the USNM (50450).

OTHER SPECIMENS EXAMINED.—ARGENTINA. *Salta:* Cafayate, 5–6 Jan 1956, L.E. Peña (1 ♀; CNC).

BOLIVIA. *Cochabamba:* Leque Palca (2 km W; 17°37.7'S, 67°57'W; 3970 m), 23 Mar 2001, W.N. Mathis (4♂; USNM).

CHILE. *Atacama:* 21 Oct 1957, L.E. Peña (3♂, 2♀; CNC). *Coquimbo:* Barrancas, 14 Mar 1955, L.E. Peña (1♂; CNC). *Malleco:* Renaico, 1 Apr 1932, D.S. Bullock (18♂, 18♀; USNM (1♂ and 6♀ with paratype labels)). *San Antonio:* Mirasol (sweeping puddles in creek bed in ravine near beach), 28 Mar 1992, A.L. Norrbom (1♀; USNM).

DISTRIBUTION (Figure 43).—Neotropical: Argentina (Salta), Bolivia (Cochabamba), Chile (Atacama, Coquimbo, Malleco, San Antonio).

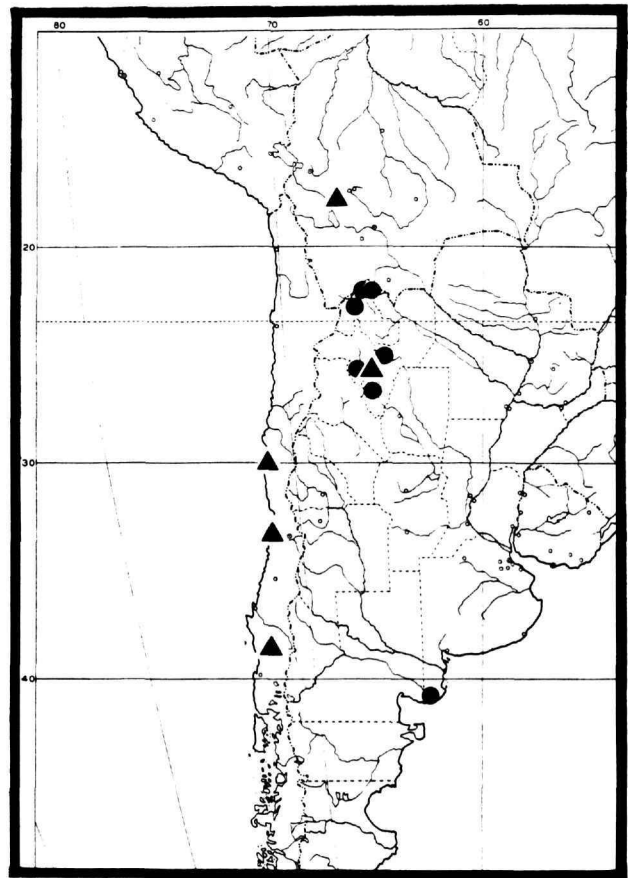

FIGURE 43.—Distribution map for *Pelomyia trivittata* (triangles) and *P. viedmae* (dots).

REMARKS.—Malloch aptly named *P. trivittata*, which is the only species among the four he described in *Pelomyia* that exhibits the paler gray bands present along dorsocentral setae. This feature, along with structures of the male terminalia (Figure 38), should easily identify this species.

15. *Pelomyia viedmae* Malloch

FIGURES 39, 43

Pelomyia viedmae Malloch, 1934:460.—Foster, 1976b:2 [Neotropical catalog].—Mathis and Munari, 1996:10 [world catalog].

DIAGNOSIS.—This species is distinguished from congeners by the following combination of characters: body with grayish brown microtomentum; frons mostly yellow, becoming brown near ocellar triangle, nearly bare of setulae; parafacial setae present as several minute setulae; fronto-orbital seta 1, reclinate; antenna mostly black; 1st flagellomere mostly orange except around arisal base; oral vibrissae absent; gena 0.32–0.35 times eye height; acrostichal setulae few, minute, in 2 scattered rows; wing crossveins not infuscate; forecoxa black in base

color, with pale gray microtomentum; midfemur not swollen, black; hindfemur slightly swollen, black; forefemoral anteroventral ctenidial comb of setae short, shorter than width of foretibia, fine; tarsomeres of normal size.

DESCRIPTION.—Body length 2.35–2.55 mm; body generally with grayish brown microtomentum.

Head: Ocellar triangle with gray microtomentum, ocellar setae 1 pair, strong; several other minute ocellar setulae; paravertic setae minute, widely separated, convergent; frons yellow, becoming brown near ocellar triangle, nearly bare of setulae; frontal lunule with silvery microtomentum; parafrons with silvery microtomentum; parafrontal setulae few, minute. Antenna mostly black; 1st flagellomere mostly orange except around arisal base. Gena 0.32–0.35 times eye height, with yellowish white microtomentum, bearing many, minute scattered setulae; shiny chitinous parafacial and peristomal stripe; palpus yellow; clypeus brown.

Thorax: Mesonotum with evenly gray to brownish gray microtomentum; pleural sclerites with gray microtomentum and shiny brown band on dorsal $\frac{1}{3}$ of anepisternum; acrostichal setulae few, minute, in 2 scattered rows. Wing hyaline; costal section ratios 7.0:2.0:1.0. Forecoxa black in base color, with pale gray microtomentum, with 2 or 3 large setae in addition to a few smaller ones; mid- and hindcoxae gray; forefemur moderately swollen, with gray microtomentum and a row of 6–8 strong setae on posterodorsal surface, posteroventral row with weaker setae, many scattered smaller setae on remainder of posterior surface, otherwise evenly setulose; forefemoral anteroventral ctenidial comb of setae fine, shorter than width of foretibia; hindfemur moderately swollen; mid- and hindfemora with black microtomentum, evenly setulose with anterior surface of midfemur bearing 1 stronger seta in middle; tibiae with black microtomentum, evenly setulose; tarsi black.

Abdomen: With dark gray microtomentum, as thorax. Male terminalia (Figure 39): ventral lobe of epandrium spatulate with a slight posterior curve; anterior and posterior margins bare of setae; medial surface bearing many long, fine setulae; surstylus wide at base, narrowed to a point distally, curved anteriorly, invested with many small setulae; aedeagus thick, pubescent; pregonite distinct, rather amorphous posteriorly; hypandrium in lateral view narrow, partially fused to postgonite; distal portion of postgonite long, tapered, pointed; basiphallus long, pointed, triangular; aedeagal apodeme much shorter than aedeagus, curved; ejaculatory apodeme with small flare; cercus widely spatulate. Female terminalia: cercus bearing stout setae.

TYPE MATERIAL.—The holotype male of *Pelomyia viedmae* is labeled "Type [round label with a red border]/*Pelomyia viedmae* Type det. JRMalloch [black subborder; '*Pelomyia viedmae* Type' handwritten]/Viedma. 23.x.1926. [23 Oct 1926]/Argentina: Terr. Rio Negro. F. & M. Edwards. B.M. 1927-63." The holotype is double mounted (pin in a rectangular sheet of celluloid), is in good condition (forelegs, except forecoxa and trochanter, and some setae, especially on head,

are missing; abdomen removed, dissected, and in an attached microvial), and is deposited in the BMNH.

OTHER SPECIMENS EXAMINED.—ARGENTINA. *Catamarca:* El Arenal (W Cord. Aconquija; 2600 m), 3–4 Oct 1968, L.E. Peña (1♂; CNC). *Jujuy:* Coyaguayma (7 km S Mina Perquitas), 4 Nov 1968, L.E. Peña (3♀; CNC); Jujuy (2200 m), 6 Jan 1956, L.E. Peña (5♂, 2♀; CNC); La Quiaca (3500 m), 23 Oct 1968, L.E. Peña (2♂, 1♀; CNC); Lecho (32 km E La Quiaca; 3300 m), 24 Oct 1968, L.E. Peña (1♀; CNC). *Salta:* Chorillos (23 km W San Antonio Los Cobres; 3800 m), 6–7 Nov 1968, L.E. Peña (1♀; CNC); El Carmen (27 km S Molinos; 1900 m), 6 Oct 1968, L.E. Peña (4♂, 4♀; CNC); Los Colorados (35 km S Pocitos; 3600 m), 7 Nov 1968, L.E. Peña (4♂; CNC); Palo Pintado (N San Carlos; 1900 m), 6 Oct 1968, L.E. Peña (1♀; CNC); Santa Rosa de Tastil, 21 Feb 1992, S.A. Marshall (1♂; GUE).

DISTRIBUTION (Figure 43).—Neotropical: Argentina (Catamarca, Jujuy, Rio Negro, Salta).

REMARKS.—This species is similar and closely related to *P. irwini* and other species of the *coronata* group. It shares all of the features of the male terminalia of this group—namely, a long, pointed basiphallus and long, tapered postgonites. The surstylus is more robust than that of most other species of the *coronata* group.

We are indebted to A.G. Irwin for helping us locate the holotype of this species.

16. *Pelomyia vockerothi*, new species

FIGURES 40–42, 44

DIAGNOSIS.—This species is distinguished from congeners by the following combination of characters: body with brownish gray microtomentum; frons yellowish orange, darker near ocellar triangle; antennal scape and pedicel black or brown, 1st flagellomere usually yellowish on entire mesal surface, lateral surface partly to mostly brownish apically; fronto-orbital seta 1, reclinate; parafrontal setulae few, minute or absent; oral vibrissae weak or absent; gena approximately 0.17–0.25 times eye height; mesonotum uniformly brownish gray, anepisternum and anepimeron mostly brownish, lower portion may have gray microtomentum; acrostichal setulae few, minute, in 2 scattered rows; wing crossveins not infusate; tarsomeres of normal size; forecoxae brown in base color, covered with silvery white microtomentum; mid- and hindfemora not swollen, entirely black; tibiae black; forefemoral anteroventral ctenidial comb of setae strong, some setae as long as narrowest width of foretibia but usually shorter.

DESCRIPTION.—Body length 1.6–2.4 mm; body generally with gray to brownish gray microtomentum.

Head: Ocellar triangle with grayish microtomentum; frons yellowish orange, darker near ocellar triangle, extreme margins with silvery gray microtomentum; frontal lunule white; fronto-orbital seta 1; parafrontal setulae absent or few, minute; ocellar setae 1 pair, well developed, another 2 or 3 minute ocellar

setulae; paraverticlar setae short, weak, widely separated, and convergent. Antennal scape and pedicel black or brown, 1st flagellomere usually yellowish on entire mesal surface, lateral surface partly to mostly brownish apically. Gena approximately 0.17–0.25 times eye height, with yellowish white microtomentum and many minute, scattered setulae; shiny chitinous stripe along parafacial and peristomal margins; palpus yellow; clypeus gray.

Thorax: Mesonotum, anepisternum, and anepimeron mostly brownish, lower portion may be microtomentose, uniformly brownish gray. Wing hyaline; costal section ratios 5.5:2.0:1.0. Forecoxa brown in base color, with silvery white microtomentum, with 2 or 3 large setae in addition to a few smaller ones; mid- and hindcoxae with gray microtomentum; forefemur moderately swollen, with black microtomentum and a row of 6–8 moderately strong setae on both posterodorsal and posteroventral surfaces, distal 2 or 3 usually strongest, many scattered smaller setae on remainder of posterior surface, otherwise evenly setulose; forefemoral anteroventral ctenidial comb of setae strong, some setae as long as narrowest width of foretibia but often shorter; hindfemur moderately swollen; mid- and hindfemora with black microtomentum, evenly setulose, anterior surface of midfemur with one stronger seta in middle; tibiae black, microtomentose, evenly setulose; tarsi black.

Abdomen: With grayish to brownish microtomentum, epandrium of male shiny, black. Male terminalia (Figures 40–42): ventral lobe of epandrium narrowed ventrally, posteriorly curved, sparsely setulose medially, virtually bare on posterior margin; surstylus long and triangular in posterior view, long and quite narrow in lateral view, sparsely setulose on exterior and interior surfaces; aedeagus wide and flat, densely pubescent; pregonites distinct, forming a hood dorsally over basiphallus and two broad weakly sclerotized lobes posteriorly, bearing many unusually long setulae on lateral surface; hypandrium in lateral view narrow; distal portion of postgonite of moderate length, spatulate; basiphallus short, pointed, triangular; ejaculatory apodeme with a small flare. Female terminalia: cercus with fine hairs only.

TYPE MATERIAL.—The holotype male is labeled “ARGENT[INA]. Jujuy[:] Agua Caliente[,] NE.Guemes, 1100m.[.] 18-19.X.68. [18-19 Oct 1968] [L.E.]Pena/HOLOTYPE *Pelomyia vockerothi* ♂ Foster & W.N.Mathis [red label; species name and ‘♂ Foster &’ handwritten].” The holotype is glued directly to the pin, is in excellent condition, and is deposited in the CNC.

Six paratypes (5♂, 1♀; CNC) bear the same label data as the holotype. Other paratypes are as follows: ARGENTINA. *Salta*: El Carmen (27 km S Molinos; 1900 m), 6 Oct 1968, L.E. Peña (6♂, 5♀; CNC); Palo Pintado (N San Carlos; 1900 m), 6 Oct 1968, L.E. Peña (20♂, 17♀; CNC); Salta (9 km S San Carlos), 5 Oct 1968, L.E. Peña (1♂, 4♀; CNC). *Tucumán*: Arroyo (14 km S El Tala; 700 m), 13–14 Oct 1968, L.E. Peña (2♂, 3♀; CNC); Tucumán, El Banado (1700 m), 5 Oct 1968, L.E. Peña (1♂, 1♀; CNC).

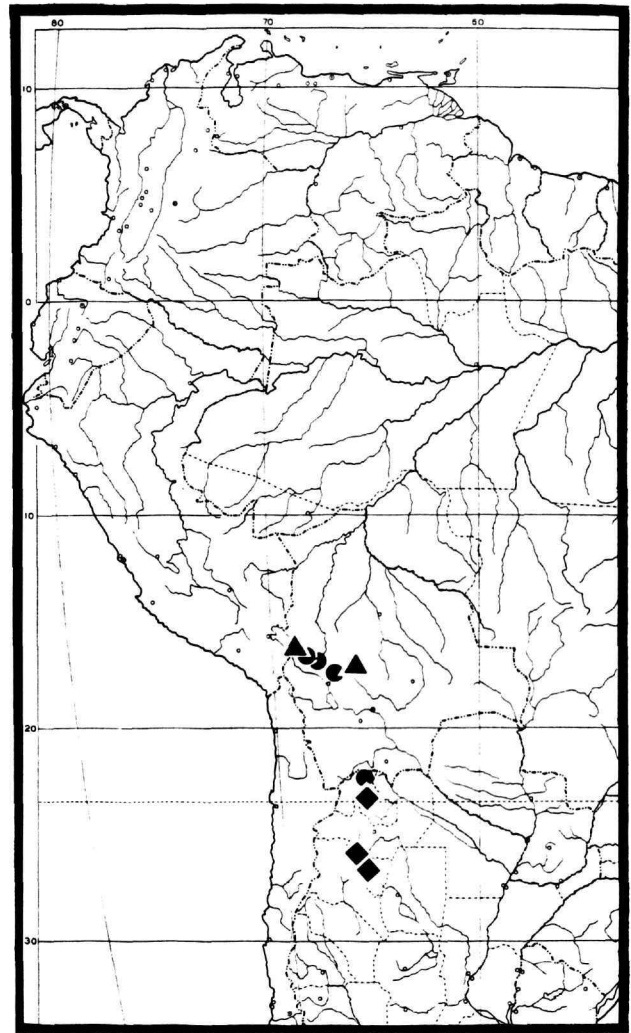

FIGURE 44.—Distribution map for *Pelomyia vockerothi* (diamonds), *P. freidbergi* (dots), and *P. curva* (triangles).

DISTRIBUTION (Figure 44).—Neotropical: Argentina (Jujuy, Salta, Tucumán).

ETYMOLOGY.—The species epithet, *vockerothi*, is a genitive patronym to honor and recognize the many contributions of J. Richard Vockeroth to our study of Tethinidae.

REMARKS.—Some details of the male genitalia of this species resemble those of *Masoniella advena* and *M. delicata*, particularly the short, indistinct pregonites that have only several long setulae remaining, and the wide, flat, densely setulose aedeagus. Like *M. advena*, this species has a narrow hypandrium.

Some variation was noted in the shape of the surstylus, with some specimens exhibiting a narrower dorsal portion than shown in Figure 40.

17. *Pelomyia freidbergi*, new species

FIGURES 44–46

DIAGNOSIS.—This species is distinguished from congeners by the following combination of characters: body generally with grayish brown microtomentum; frons dark reddish brown, margins with silvery microtomentum; parafrontal setae few, minute, 1 slightly larger seta near base of antenna; fronto-orbital seta 1, reclinate; antenna entirely black; oral vibrissae short, weak; gena 0.28–0.38 times eye height; acrostichal setulae minute, in 2 scattered rows; wing crossveins not infuscate; tarsomeres of normal size; forecoxa black in base color; fore- and hindfemora barely swollen, midfemur slender; legs entirely black; forefemoral anteroventral ctenidial comb short but distinct (shorter than width of foretibia).

DESCRIPTION.—Body length 2.63–3.30 mm; body generally with grayish brown microtomentum.

Head: Ocellar triangle with gray microtomentum; frons dark reddish brown, margins with broadly silvery microtomentum; frontal lunule dark silvery, parafrontal setulae few, minute, with 1 slightly larger seta near base of antenna; ocellar setae 1 pair, strong, several minute, weak ocellar setulae; paravertical setae short, separated by width of ocellar triangle, convergent. Antenna entirely black. Gena 0.28–0.38 times eye height, with yellowish to golden microtomentum, bearing many minute, scattered setulae; shiny chitinous stripe along parafacial margin, another stripe from base of antenna

ventrad to level of ventral margin of eye varying in distinctness; palpus dark yellow to orange; clypeus with gray microtomentum.

Thorax: Mesonotum mostly grayish brown, microtomentose, with a distinct brown stripe along acrostichal setae; pleural surfaces largely uniformly grayish brown; anepisternum slightly darker. Wing hyaline; costal section ratios 7.6:2.5:1.0. Forecoxa black in base color, with grayish microtomentum, with 2 or 3 large setae in addition to a few smaller ones; mid- and hindcoxae concolorous with forecoxa; fore- and hindfemora only slightly swollen, with black microtomentum, forefemur with 2 rows of 4–8 strong setae on both posterodorsal and posteroventral surfaces, distal 2 or 3 stronger, many scattered smaller setae on remainder of posterior surface, otherwise evenly setulose; forefemoral anteroventral ctenidial comb indistinct, setae moderately long; midfemur slender, evenly setulose with anterior surface of midfemur bearing 1 stronger seta in middle; tibiae and tarsi black, evenly setulose.

Abdomen: Uniformly with brown microtomentum, only extreme posterior margin of each segment slightly paler brown. Male terminalia (Figures 45, 46): ventral lobe of epandrium long, slender, with a posterior curvature at apex and curved medially, anterior margin bare, posterior margin with dorsal ½ bearing many long, posteriorly directed setae, ventral ½ bearing a few fine setulae; surstylus narrow, spatulate, ½ length of ventral lobe, covered with moderately strong

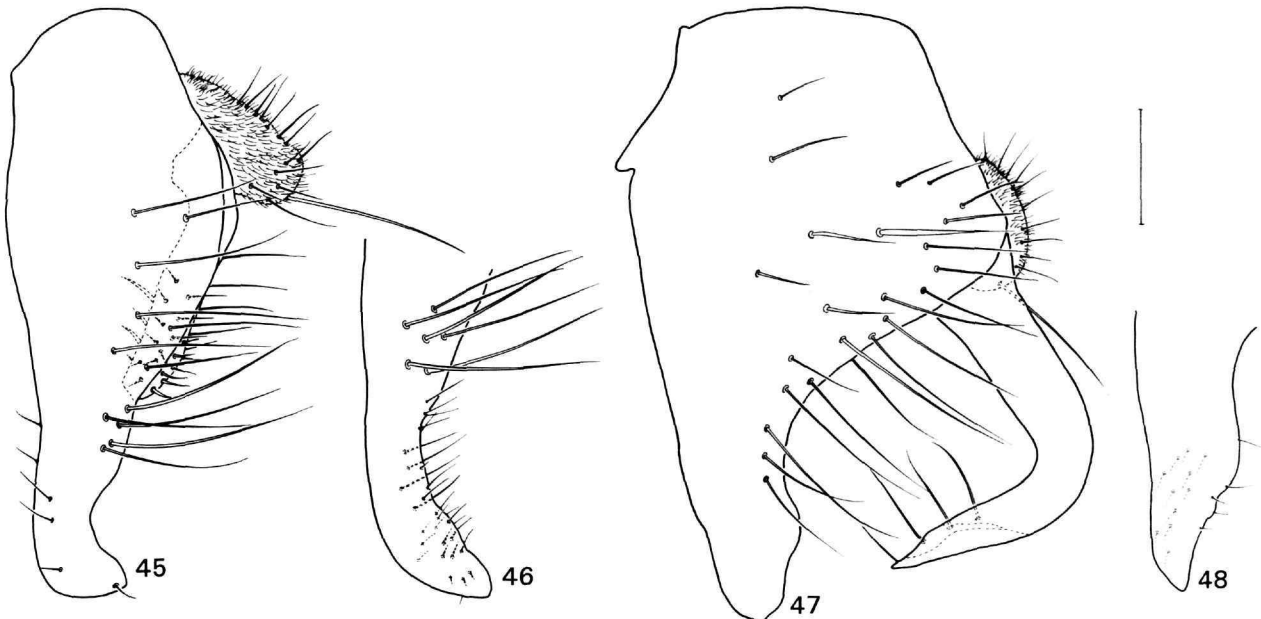

FIGURES 45–48.—External male terminalia (epandrium, cercus, surstylus): 45, *Pelomyia freidbergi*, lateral aspect; 46, *P. freidbergi*, ventral process, ventroblique aspect; 47, *P. curva*, lateral aspect; 48, *P. curva*, ventral process, ventroblique aspect. Scale bar = 0.1 mm.

setulae; aedeagus thick, pubescent; pregonite distinct, spatulate, partially fused with postgonite; hypandrium narrow in lateral view; postgonite spatulate; basiphallus long, pointed, triangular; ejaculatory apodeme moderately flared, somewhat triangular, completely sclerotized. Female terminalia: cercus bearing many well-developed setulae, not particularly thickened.

TYPE MATERIAL.—The holotype male is labeled “**BOLIVIA**. La Paz: El Alto (23 km S; 16°42.7'S, 68°11.2'W; 3860m), 21 Mar 2001[,] Amnon Freidberg/Holotype *Pelomyia freidbergi* ♂ Foster & W.N.Mathis [red label; species name and '♂ Foster &' handwritten].” The holotype is double mounted (mounted in a block of white plastic), is in excellent condition, and will be deposited in the MNBL.

Twenty-two paratypes (12♂, 10♀; USNM) bear the same label data as the holotype. Other paratypes are as follows: **BOLIVIA**. *Cochabamba*: Japo (18 km W; 17°35'S, 66°56.2'W; 4060 m), 23 Mar 2001, W.N. Mathis (1♂, 1♀; USNM); Leque Palca (2 km W; 17°38.2'S, 66°58.4'W; 3950 m), 23 Mar 2001, A. Freidberg (1♂; USNM); Pongo (5 km W; 17°42.9'S, 66°36'W; 3820 m), 23 Mar 2001, A. Freidberg (1♀; MNBL). *La Paz*: El Alto (14 km S; 16°40.1'S, 68°11'W; 3900 m), 20 Mar 2001, A. Freidberg (2♂; NMBL, USNM); La Paz (6 km NE; 16°25.7'S, 68°04.3'W; 4130 m), 19 Mar 2001, A. Freidberg, W.N. Mathis (1♂, 7♀; NMBL, USNM); La Paz (15 km NE; 16°24.6'S, 68°02.9'W; 4300 m), 29 Mar 2001, S. Gaimari (1♀; USNM); La Paz (30 km S; 16°48.7'S, 68°04.3'W; 4000 m), 29 Mar 2001, S. Gaimari (1♀; USNM); Patacamaya (7 km NE; 17°09.5'S, 67°56.7'W; 3800 m), 21 Mar 2001, A. Freidberg, W.N. Mathis (4♂, 12♀; MNBL, USNM).

OTHER SPECIMEN EXAMINED.—**ARGENTINA**. *Jujuy*: Cochino (llama dung; 3700 m), 26 Feb 1992, S.A. Marshall (1♂; GUE).

DISTRIBUTION (Figure 44).—Neotropical: Argentina (*Jujuy*), Bolivia (*Cochabamba*, *La Paz*).

ETYMOLOGY.—The species epithet, *freidbergi*, is a genitive patronym to honor the collector of the type series, Amnon Freidberg.

REMARKS.—The structures of the male terminalia of this species are typical of the *coronata* group: the hypandrium is narrow; the pre- and postgonites are partially fused; and the basiphallus is long, narrow, and triangular.

18. *Pelomyia curva*, new species

FIGURES 44, 47, 48

DIAGNOSIS.—This species is distinguished from congeners by the following combination of characters: body generally with dark gray microtomentum and slightly paler gray on notopleuron, supra-alar area, anteroventral portion of anepisternum, and along line of dorsocentral setae; frons yellow in middle, dark orange elsewhere, margins with silvery microto-

mentum; parafrontal setae few, minute, 1 slightly larger seta near base of antenna; fronto-orbital seta 1, reclinate; antenna entirely black; oral vibrissae small, weak; gena 0.35–0.44 times eye height; mesonotum with gray microtomentum and 2 distinct brown stripes anteriorly between dorsocentral tracks, stripes merging posteriorly into 1 wide stripe that continues onto scutellum; another short, brown stripe between dorsocentral track and intra-alar setae; acrostichal setulae few, minute, in 2 scattered rows; wing crossveins not infuscate; tarsomeres of normal size; forecoxa black in base color; mid- and hindfemora only slightly swollen, entirely black; forefemoral anteroventral ctenidial comb indistinct, setae weak, thin, more widely spaced.

DESCRIPTION.—Body length 2.63–2.93 mm; body generally with gray microtomentum.

Head: Ocellar triangle with gray microtomentum; frons yellow medially, otherwise dark orange, extreme margins with silvery microtomentum; frontal lunule silvery, parafrontal setulae few, minute, with 1 slightly larger near base of antenna; ocellar setae 1 pair, strong, another pair of minute ocellar setulae; paraverticilar setae minute, widely separated, and convergent. Antenna entirely black. Gena 0.35–0.44 times eye height, with yellowish microtomentum, bearing many minute, scattered setulae; shiny chitinous stripe along parafacial and peristomal margins; palpus yellow; clypeus with gray microtomentum.

Thorax: Mesonotum with gray microtomentum and 2 distinct brown stripes anteriorly between dorsocentral tracks, stripes merging posteriorly into 1 wide stripe that continues onto scutellum; another short, brown stripe between dorsocentral track and intra-alar setae. Wing hyaline; costal section ratios 5.7:1.6:1.0. Forecoxa black in base color, with grayish microtomentum, with 2 or 3 large setae in addition to a few smaller ones; mid- and hindcoxae concolorous with forecoxa; forefemur moderately swollen, with black microtomentum and a row of 6–8 strong setae on both posterodorsal and posteroventral surfaces, distal 2 or 3 usually strongest, many scattered smaller setae on remainder of posterior surface, otherwise evenly setulose; forefemoral anteroventral ctenidial comb indistinct, setae weak, thin, widely spaced; hindfemur slightly swollen; mid- and hindfemora with black microtomentum, evenly setulose with anterior surface of midfemur bearing 1 stronger seta in middle; tibiae black, evenly setulose; tarsi black.

Abdomen: With uniformly gray microtomentum, only extreme posterior margin of each segment slightly paler. Male terminalia (Figures 47, 48): ventral lobe of epandrium long, narrow, pointed, anterior margin bearing 2 rows of fine setulae, posterior margin bearing sparse row of long, moderately strong setae; surstylus bearing few setulae, bent at about 90°, spatulate distally; aedeagus thick, pubescent; pregonite distinct, apices widely separated posteriorly and relatively short; hypandrium narrow in lateral view; distal portion of post-

gonite long, narrow; basiphallus long, pointed, triangular; ejaculatory apodeme with moderately flared portion extremely lightly sclerotized, clear. Female terminalia: cercus bearing many well-developed setulae.

TYPE MATERIAL.—The holotype male is labeled “**BOLIVIA**. Cochabamba: Leque Palca (2 km W; 17°37.7’S, 67°57’W; 3970 m), 23 Mar 2001[.] Wayne N. Mathis/HOLOTYPE *Pelomyia curva* ♂ Foster & W.N.Mathis [red label; species name and ‘♂ Foster &’ handwritten].” The holotype is double mounted (minuten in a block of white plastic), is in excellent condition, and will be deposited in the MNBL.

Seventeen paratypes (15♂, 2♀ (5♂, 2♀ with A. Freidberg as collector); MNBL, USNM) bear the same label data as the holotype. Other paratypes are as follows: **BOLIVIA**. *Cochabamba*: Pongo (5 km W; 17°42.9’S, 66°36’W; 3820 m), 23 Mar 2001, A. Freidberg (2♂, 1♀; MNBL, USNM). *La Paz*: La Paz (15 km NE; 16°24.6’S, 68°02.9’W; 4300 m), 29 Mar 2001, A. Freidberg (3♂; MNBL, USNM).

DISTRIBUTION (Figure 44).—Neotropical: Bolivia (Cochabamba, La Paz).

ETYMOLOGY.—The species epithet, *curva*, is of Latin derivation and alludes to the curved apex of the surstylus.

REMARKS.—The surstylus of this species is unusual in being curved anteriorly at 90° and in having sparse setae and setulae. The characters of the pregonite, postgonite, and the hypandrium clearly place this species in the *coronata* group. This species is easily identified by the two brown stripes between the dorsocentral tracks that merge into a single, wide stripe that continues onto the scutellum.

19. *Pelomyia univittata*, new species

FIGURES 49, 53

DIAGNOSIS.—This species is distinguished from congeners by the following combination of characters: body generally pale gray, microtomentose, with slightly paler gray microtomentum on notopleuron, supra-alar area, anteroventral portion of anepisternum, and along line of dorsocentral setae; frons pale yellow in middle, slightly darker elsewhere, margins with silvery microtomentum; antenna mostly black with medial and anteroventral surfaces of 1st flagellomere orange; fronto-orbital seta 1, reclinate; parafrenal setulae few, minute; oral vibrissae minute, weak, or not evident; gena approximately 0.36–0.45 times eye height; mesonotum with gray microtomentum, with acrostichal area with brown band, becoming darker posteriorly and continuing on scutellum; upper portion of anepisternum brownish, lower portion with grayish microtomentum; acrostichal setulae minute, scattered; wing crossveins not infuscate; tarsomeres of normal size; forecoxa black in base color; mid- and hindfemora only slightly swollen, entirely black; although forefemoral anteroventral ctenidial comb of setae present, setulae weak, thin, unevenly spaced.

DESCRIPTION.—Body length 2.27–2.45 mm; body generally with pale grayish microtomentum.

Head: Ocellar triangle with grayish microtomentum; frons pale yellow in middle, remainder darker yellow, extreme margins with silvery gray microtomentum; frontal lunule silvery; fronto-orbital seta 1; parafrenal setulae few, minute; ocellar setae 1 pair, well developed, otherwise bare or bearing another 2 or 3 minute, weak ocellar setulae; paraverticilar setae short, weak, widely separated, and convergent. Antennal scape and pedicel black, 1st flagellomere usually orange on entire mesal surface, lateral surface partly to mostly brownish. Gena approximately 0.36–0.45 times eye height, with whitish yellow microtomentum and many minute, scattered setulae; shiny chitinous stripe along parafacial and peristomal margins; palpus yellow; clypeus gray.

Thorax: Mesonotum with gray microtomentum, with acrostichal area with brown band, becoming darker posteriorly and continuing on scutellum; upper portion of anepisternum faintly brownish, lower portion with grayish microtomentum. Wing hyaline; costal section ratios 6.5:2.0:1.0. Forecoxa black in base color with white microtomentum, with 2 or 3 large setae in addition to a few smaller ones; mid- and hindcoxae with grayish microtomentum; forefemur slightly swollen, with gray microtomentum and a row of 6–8 moderately strong setae on posterodorsal surface, posteroventral row weaker, distal 2 or 3 strongest, many scattered smaller setae on remainder of posterior surface, otherwise evenly setulose; forefemoral anteroventral ctenidial comb of setae indistinct, with only a few unevenly spaced setulae, length shorter than width of foretibia; hindfemur slightly swollen; mid- and hindfemora with gray microtomentum, evenly setulose, anterior surface of midfemur lacking a stronger seta in middle; tibiae with black microtomentum, evenly setulose; tarsi brown to black.

Abdomen: Male terminalia (Figure 49): ventral lobe of epandrium broadly spatulate, bare on lateral surfaces, medial surface with many fine, sinuous setulae; surstylus rounded, spatulate distally with many short setae; aedeagus thick, pubescent; pregonite distinct but partially fused with postgonite; hypandrium in lateral view narrow; distal portion of postgonite spatulate; basiphallus long, pointed, triangular; ejaculatory apodeme moderately flared. Female unknown.

TYPE MATERIAL.—The holotype male is labeled “**BOLIVIA**. Oruro: Pazña (S of town; 18°36.2’S, 66°54.7’W[.] 3750m), 22 Mar 2001[.] Amnon Freidberg/HOLOTYPE *Pelomyia univittata* ♂ Foster & W.N.Mathis [red label; species name and ‘♂ Foster &’ handwritten].” The holotype is double mounted (minuten in a small block of plastic), is in excellent condition, and will be deposited in the MNBL. Paratypes bear the same label data as the holotype except with Wayne N. Mathis as collector (6♂; MNBL, USNM).

DISTRIBUTION (Figure 53).—Neotropical: Bolivia (Oruro).

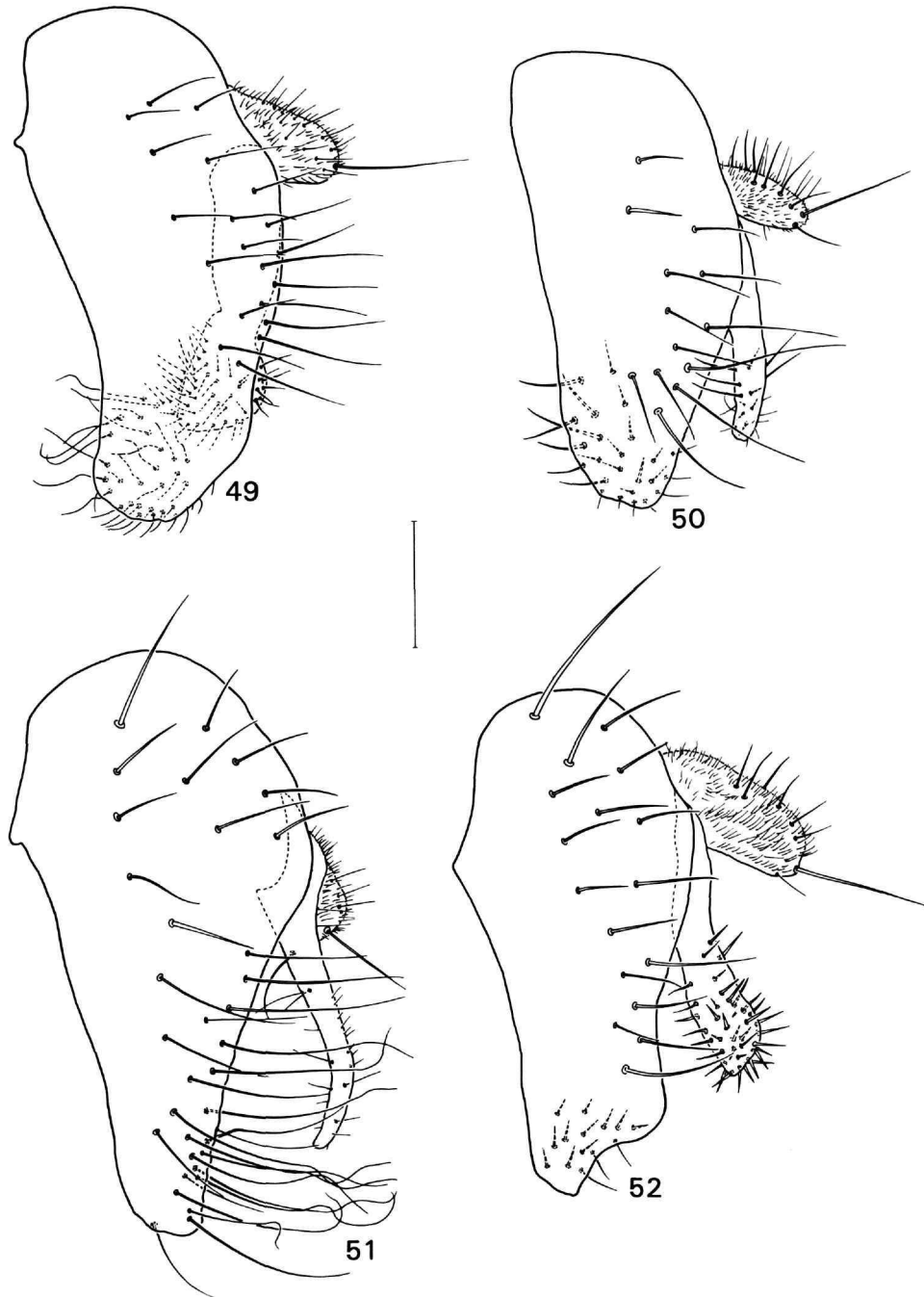

FIGURES 49-52.—External male terminalia (epandrium, cercus, surstylus): 49, *Pelomyia univittata*, lateral aspect; 50, *P. nigripalpis*, lateral aspect; 51, *P. undulata*, lateral aspect; 52, *P. boliviensis*, lateral aspect. Scale bar = 0.1 mm.

ETYMOLOGY.—The species epithet, *univittata*, is of Latin derivation and refers to the pale, brownish midstripe on the mesonotum.

REMARKS.—The ventral lobe of *P. univittata* is broadly spatulate and is completely bare on the lateral surface; the

medial surfaces, however, exhibit a dense covering of long, rather wavy setulae. The mesonotum of this species is distinct in having one faintly brownish stripe medially that extends from the anterior margin to the posterior margin of the scutellum.

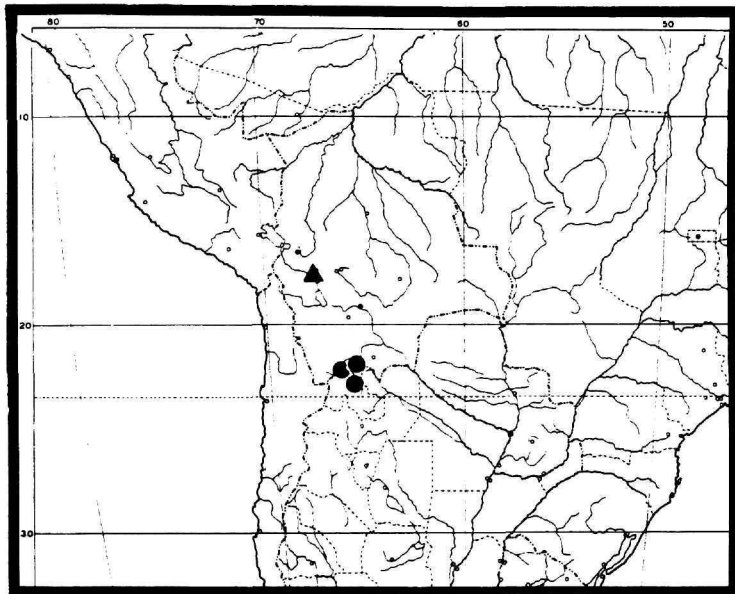

FIGURE 53.—Distribution map for *Pelomyia univittata*, *P. nigripalpis*, and *P. undulata* (triangle), and *P. crassispina* (dots).

20. *Pelomyia nigripalpis*, new species

FIGURES 50, 53

DIAGNOSIS.—This species is distinguished from congeners by the following combination of characters: body entirely with brownish gray microtomentum; frons orange; antenna entirely black; fronto-orbital seta 1, reclinate; parafrontal setulae few, minute, 1 slightly larger seta near base of antenna; oral vibrissae minute, weak; gena approximately 0.46 times eye height; mesonotum and lateral sclerites uniformly brownish gray with paler gray notopleuron; acrostichal setulae few, minute, in 2 scattered rows; wing crossveins not infuscate; tarsomeres of normal size; forecoxae black in base color; mid- and hindfemora slightly swollen, entirely black; tibiae black; setae of anteroventral comb short and well developed, shorter than width of foretibia.

DESCRIPTION.—Body length approximately 1.90–2.50 mm; body entirely with brownish gray microtomentum.

Head: Ocellar triangle with grayish microtomentum; frons orange, extreme margins with silvery gray microtomentum; frontal lunule silvery; fronto-orbital seta 1; parafrontal setulae few, minute, with 1 slightly larger near base of antenna; ocellar seta 1, well developed, another 2 or 3 minute ocellar setulae; paravertical setae short, weak, widely separated, and convergent. Antenna entirely black. Gena approximately 0.46 times eye height, with yellowish white microtomentum and many minute, scattered setulae; shiny chitinous stripe along parafacial and peristomal margins; palpus black; clypeus gray.

Thorax: Mesonotum and lateral sclerites with uniformly brownish gray microtomentum and paler gray notopleuron. Wing hyaline; costal section ratios 5.0:2.0:0.9. Forecoxa black in base color, with white microtomentum, with 2 or 3 large setae in addition to a few smaller ones; mid- and hindcoxae

mostly with black microtomentum; forefemur slightly swollen, with black microtomentum and a row of 6–8 strong setae on both posterodorsal and posteroventral surfaces, distal 2 or 3 strongest, many scattered smaller setae on remainder of posterior surface, otherwise evenly setulose; forefemoral anteroventral ctenidial comb of setae strong and short, length shorter than width of foretibia; hindfemur slightly swollen; mid- and hindfemora with black microtomentum, evenly setulose, anterior surface of midfemur with one stronger seta in middle; tibiae gray, microtomentose, evenly setulose; tarsi black.

Abdomen: With brownish gray microtomentum. Male terminalia (Figure 50): ventral lobe of epandrium broadly spatulate, anterior margin bare, ventral mesal surface with many short, moderately well-developed setae; posterior margin bare; surstylus relatively long, spatulate with a few long setulae and some short, weak setulae; aedeagus thick, pubescent; pregonites evident; hypandrium in lateral view narrow; distal portion of postgonite spatulate; basiphallus long, pointed, triangular; ejaculatory apodeme moderately flared. Female unknown.

TYPE MATERIAL.—The holotype male is labeled “BOLIVIA. Oruro: Pazña (S of town; 18°36.2’S, 66°54.7’W; 3750m), 22 Mar 2001[,] Wayne N. Mathis/Holotype *Pelomyia nigripalpis* ♂ Foster & W.N.Mathis [red label; species name and ‘♂ Foster &’ handwritten].” The holotype is double mounted (minuten in a small block of plastic), is in excellent condition, and will be deposited in the MNBL. Paratypes bear the same label data as the holotype (2♂; USNM).

DISTRIBUTION (Figure 53).—Neotropical: Bolivia (Oruro).

ETYMOLOGY.—The species epithet, *nigripalpis*, is of Latin derivation and refers to the black maxillary palpus.

REMARKS.—This is the only species of *Pelomyia* that has a black maxillary palpus.

21. *Pelomyia undulata*, new species

FIGURES 51, 53

DIAGNOSIS.—This species is distinguished from congeners by the following combination of characters: body with brownish microtomentum; frons dark orange; antenna mostly black with small faintly orange part of ventral surface of 1st flagellomere; fronto-orbital seta 1, reclinate; parafrontal setulae few, minute; oral vibrissae weak or absent; gena approximately 0.40 times eye height; mesonotum with uniformly brown microtomentum; notopleuron gray; anepisternum and anepimeron mostly brown; acrostichal setulae few, minute, in 2 scattered rows; wing crossveins not infuscate; tarsomeres of normal size; forecoxa black or brown in base color, covered with silvery gray microtomentum; mid- and hindfemora slightly swollen, entirely black; tibiae black; forefemoral anteroventral ctenidial comb of setae short, weak, shorter than width of foretibia.

DESCRIPTION.—Body length 1.80–2.00 mm; body generally with brown microtomentum.

Head: Ocellar triangle with grayish microtomentum; frons dark orange, extreme margins with silvery gray microtomentum; frontal lunule silvery; parafrontal setulae few, minute, with 1 slightly larger seta near base of antenna; ocellar seta 1, well developed, another 2 or 3 minute ocellar setulae; paravertic setae short, weak, widely separated and convergent. Antenna mostly black with faintly yellow part of ventral surface of 1st flagellomere. Gena approximately 0.40 times eye height, with whitish gray microtomentum and many minute, scattered setulae; shiny chitinous stripe along parafacial and peristomal margins; palpus yellow; clypeus gray.

Thorax: Mesonotum uniformly brown; notopleuron gray; anepisternum and anepimeron mostly brown. Wing hyaline; costal section ratios 7.0:2.0:1.0. Forecoxa black in base color, with silvery gray microtomentum, with 2 or 3 large setae in addition to a few smaller ones; mid- and hindcoxae with black microtomentum; forefemur slightly swollen, with black microtomentum and a row of 6–8 strong setae on posterodorsal surface, posteroventral row weaker except for distal 2 or 3 setae, many scattered smaller setae on remainder of posterior surface, otherwise evenly setulose; forefemoral anteroventral ctenidial comb of setae weak, shorter than width of foretibia; hindfemur slightly swollen; mid- and hindfemora with black microtomentum, evenly setulose, anterior surface of midfemur lacking 1 stronger seta in middle; tibiae with black microtomentum, evenly setulose; tarsi black.

Abdomen: With brown microtomentum, extreme posterior margin of each tergite pale brown. Male terminalia (Figure 51): ventral lobe of epandrium triangular, narrowed ventrally to a point, anterior margin bare, posterior margin with tuft of many long, sinuous setae; surstylus relatively long, narrow, tapered to point, relatively bare; aedeagus thick, pubescent; pregonite distinct; hypandrium in lateral view narrow; distal portion of postgonite spatulate; basiphallus long, pointed,

triangular; ejaculatory apodeme moderately flared. Female unknown.

TYPE MATERIAL.—The holotype male is labeled “**BOLIVIA.** Oruro: Pazña (S of town; 18°36.2'S, 66°54.7'W; 3750m), 22 Mar 2001[,] Amnon Freidberg/Holotype *Pelomyia undulata* ♂ Foster & W.N.Mathis [red label; species name and ‘♂ Foster &’ handwritten].” The holotype is double mounted (minuten in a small block of plastic), is in excellent condition, and will be deposited in the MNBL.

One paratype (♂; USNM) bears the same label data as the holotype. One other paratype is as follows: **BOLIVIA.** Oruro: Challapata (45 km S; 19°12.9'S, 66°47.7'W; 3690 m), 22 Mar 2001, A. Freidberg (♂; USNM).

DISTRIBUTION (Figure 53).—Neotropical: Bolivia (Oruro).

ETYMOLOGY.—The species epithet, *undulata*, is of Greek derivation and refers to the tuft of long, wavy setulae on the ventral process.

REMARKS.—Although this species is typical of the *coronata* group, it is distinguished from congeners of this group by the ventral lobe that bears a tuft of long, sinuous setae on the posterior margin.

22. *Pelomyia boliviensis*, new species

FIGURES 52, 54

DIAGNOSIS.—This species is distinguished from congeners by the following combination of characters: body with brown microtomentum; frons pale orange, few minute scattered setulae; parafrontal setae present as several minute hairs; fronto-orbital seta 1, reclinate; antenna black; oral vibrissae minute, weak; gena 0.40 times eye height; acrostichal setulae absent; wing crossveins not infuscate; tarsomeres of normal size; forecoxa black in base color, with silvery white microtomentum; mid- and hindfemora only slightly swollen, black; forefemoral anteroventral ctenidial comb of setae weak, shorter than width of foretibia.

DESCRIPTION.—Body length 2.40 mm; body generally with brown microtomentum.

Head: Ocellar triangle with gray microtomentum, ocellar setae 1 pair, strong, black; another pair of minute ocellar setulae; paravertic setae minute, widely separated, convergent; frons pale orange with a few minute setulae; frontal lunule with silvery microtomentum; parafrons with silvery microtomentum; parafrontal setulae few, minute, with 1 slightly larger near base of antenna. Antenna black. Gena 0.40 times eye height; with yellowish microtomentum, with minute scattered setulae; shiny chitinous parafacial and peristomal stripe; palpus yellow; clypeus gray.

Thorax: Mesonotum with evenly gray to brownish microtomentum; pleural sclerites with evenly brown microtomentum; dorsocentral setae 4 (1 + 3); acrostichal setulae absent. Wing hyaline; costal section ratios 7.0:1.8:1.0. Forecoxa black in base color, with whitish gray microtomentum, with 2 or 3 large setae in addition to a few smaller ones; mid- and hind-

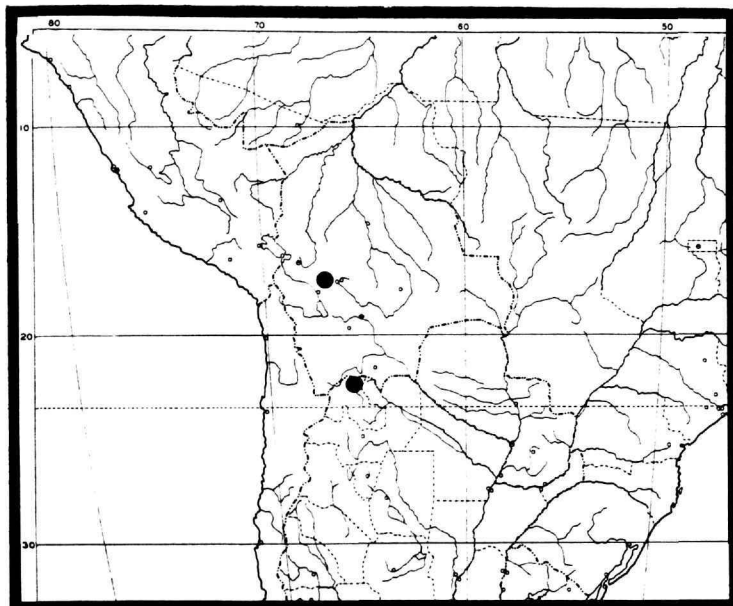

FIGURE 54.—Distribution map for *Pelomyia boliviensis* (dots).

coxae concolorous with forecoxa; forefemur slightly swollen, with black microtomentum and a row of 6–8 strong setae on both posterodorsal and posteroventral surfaces, distal 2 or 3 usually the longest, many scattered smaller setae on remainder of posterior surface, otherwise evenly setulose; forefemoral anteroventral ctenidial comb of setae weak, shorter than width of foretibia; hindfemur slightly swollen; mid- and hindfemora with black microtomentum, evenly setulose with anterior surface of midfemur lacking a stronger seta in middle; tibiae with black microtomentum, evenly setulose; tarsi black.

Abdomen: With grayish brown microtomentum. Male terminalia (Figure 52): ventral lobe of epandrium narrowed anteroventrally into a broad point, anterior margin bare; surstylus curved medially, armed distally with many short setae; aedeagus thick, pubescent; pregonite distinct, long, tapered, pointed, partially fused to postgonite; hypandrium in lateral view narrow; distal portion of postgonite spatulate; basiphallus long, pointed, triangular; cercus spatulate; ejaculatory apodeme with small flare. Female unknown.

TYPE MATERIAL.—The holotype male is labeled “**BO-LIVIA**. Cochabamba: Leque Palca (2 km W; 17°38.2'S, 66°58.4'W; 3950 m), 23 Mar 2001[.] Wayne N. Mathis/HOLOTYPE *Pelomyia boliviensis* ♂ Foster & W.N.Mathis [red label; species name and ‘♂ Foster &’ handwritten].” The holotype is double mounted (minuten in a small block of plastic), is in excellent condition, and will be deposited in the MNBL.

OTHER SPECIMEN EXAMINED.—ARGENTINA. *Jujuy*: Tres Cruces (lakeside; 3700 m), 26 Feb 1992, S.A. Marshall (1♂; GUE).

DISTRIBUTION (Figure 54).—Neotropical: Argentina (*Jujuy*), Bolivia (Cochabamba).

ETYMOLOGY.—The species epithet, *boliviensis*, is of Latin derivation and refers to the country where the type locality is.

REMARKS.—This species is similar to *P. nigritarsis* and *P. robustiseta* and is distinguished from them by characters of the male terminalia. The female is unknown.

The *melanocera* Group

DIAGNOSIS.—Species of the *melanocera* group have body lengths of 2.40–3.15 mm and are distinguished from other species groups by the following combination of characters.

Head: Higher than long; gena 0.26–0.50 times eye height, with scattered minute setulae over entire surface; peristomal margin with shiny chitinous stripe; labellum short; eye round, facets generally becoming larger anteriorly; fronto-orbital setae 2 or 3; parafrontal setae few, minute; 1 well-developed pair of ocellar setae, often with at least 2 or 3 additional weak setulae; true postvertical setae absent; paraverticilar setae usually widely separated, minute, convergent; oral vibrissae usually weak, small; antenna porrect.

Thorax: With gray to brown microtomentum, often with brownish band along pleural surfaces, specifically anepisternum; acrostichal setulae either present or absent, if present then few, minute, in 2 to several scattered rows; disk of scutellum bare. Wing with crossvein bm-cu complete to incomplete, never entirely lacking. Forefemur in both sexes with anteroventral ctenidial comb varying from absent to moderately well developed; forecoxa yellow, gray, or black in base color with grayish to white or silvery microtomentum.

Abdomen: With brownish to gray microtomentum, may become paler gray laterally, extreme posterior margins of sternites usually paler. Male terminalia (Figures 56–59): epandrium

with ventral processes spatulate, curved, or truncate, bearing weak to well-developed peg-like setae on medial or posterior surface; true surstylus spatulate, varying in length, bearing either weak setulae or strong, peg-like setae distally; surstylus positioned lateral to cercus, articulated with subepandrial sclerite; subepandrial sclerite simple, plate-like, never in an X- or H-shaped configuration, articulated with hypandrium anteriorly and with the surstylus posteriorly; cercus usually about $\frac{1}{2}$ length of surstylus, pubescent, and bearing many long fine setae, apical setae longest; hypandrium rather stout in lateral view, as in most *Tethina* and many other Tethinae, 2-armed with arms separated posteriorly, articulated with subepandrial sclerite and epandrium, arms fused anteriorly with aedeagal apodeme; hypandrial apodeme absent. Internal copulatory apparatus: basiphallus articulated with posterior apex of aedeagal apodeme, round (more triangular in *P. grisecoxa*); opening in center of basiphallus, allowing ejaculatory duct to pass through to aedeagus; pregonites completely fused to hypandrium; usually only a few setulae remaining; postgonites without moderate thickening in middle, with distal portion usually widely spatulate and simple compared with many species of the *coro-*

nata group; postgonites articulated with aedeagal apodeme just posterior to fusion point of hypandrium; aedeagal apodeme long, rod-like; ejaculatory apodeme varying from lacking any flare to moderately flared; aedeagus sometimes shorter and thicker than that of most species of the *coronata* group, with micropubescence often much shorter. Female terminalia: cercus bearing setae varying from moderately well-developed to long, thick spines.

DISCUSSION.—Several distinguishing characters for the *melanocera* group were noted previously in the "Discussion" of the *coronata* group (page 6). Here we emphasize only synapomorphies that corroborate the monophyly of the *melanocera* group: (6) crossvein bm-cu is at least partially developed, often complete and well developed; and (7) nodulate flexion zone of postgonite is present and secondarily simple. (Other characters used to distinguish this group are as follows: males may have strong, peg-like setae on the ventral lobe or surstylus; subepandrial sclerite is usually a single plate; and hypandrium resembles that of *Tethina* and other Tethinae, with pregonites more fully fused with hypandrium and bearing only a few setae at the location of the pregonites.)

Key to Species of the *melanocera* Group

1. Frons mostly yellow to orange 2
Frons dark, infuscate brown to black 4
2. Fronto-orbital setae 3 24. *P. crassispina*, new species
Fronto-orbital setae 2 3
3. Legs entirely with gray to black microtomentum; forecoxa dark in base color
. 23. *P. crassiseta*, new species
Foretibia yellow on basal $\frac{1}{3}$; basal 2 tarsomeres yellow; forecoxa yellow in base color
. new species (not to be described; Chile)
4. Frons orange toward antennal bases; gena at most only 0.35 times eye height
. 25. *P. grisecoxa*, new species
Frons entirely dark, infuscate brown to black; gena fully 0.5 times eye height
. 26. *P. melanocera*, new species

23. *Pelomyia crassiseta*, new species

FIGURES 55, 56, 60

DIAGNOSIS.—This species is distinguished from congeners by the following combination of characters: body generally with grayish brown microtomentum dorsally, pleural sclerites grayish with anepisternum with brownish microtomentum dorsally; frons yellowish to orange with a few minute setulae in a triangular pattern; parafrontal setae present as row of minute hairs; fronto-orbital setae 2, reclinate; ocellar triangle with gray microtomentum; antenna mostly brown, 1st flagellomere orange with broad area around base of arista; oral vibrissae small, weak; gena 0.5 times eye height; acrostichal setulae minute, scattered; wing crossveins not infuscate; crossvein bm-cu present; tarsomeres of normal size; forecoxa black in base

color with grayish microtomentum; mid- and hindfemora not swollen; forefemoral anteroventral ctenidial comb of setae short, moderately strong.

DESCRIPTION.—Body length 2.40–3.10 mm; body with brown to brownish gray microtomentum.

Head (Figure 55): Ocellar triangle with gray microtomentum; frons yellowish orange with a few minute setulae in a triangular pattern; parafrons with yellow microtomentum; frontal lunule yellow; fronto-orbital setae 2; parafrontal setulae present as a row of minute setulae; ocellar seta 1, well developed, with a few short, weak setulae; paravertical setae minute, convergent. Antenna mostly brown, 1st flagellomere orange with broad dark area around base of arista. Gena 0.5 times eye height, with pale yellow microtomentum, a few minute, scattered setulae, and row of peristomal setulae; face pale yellow;

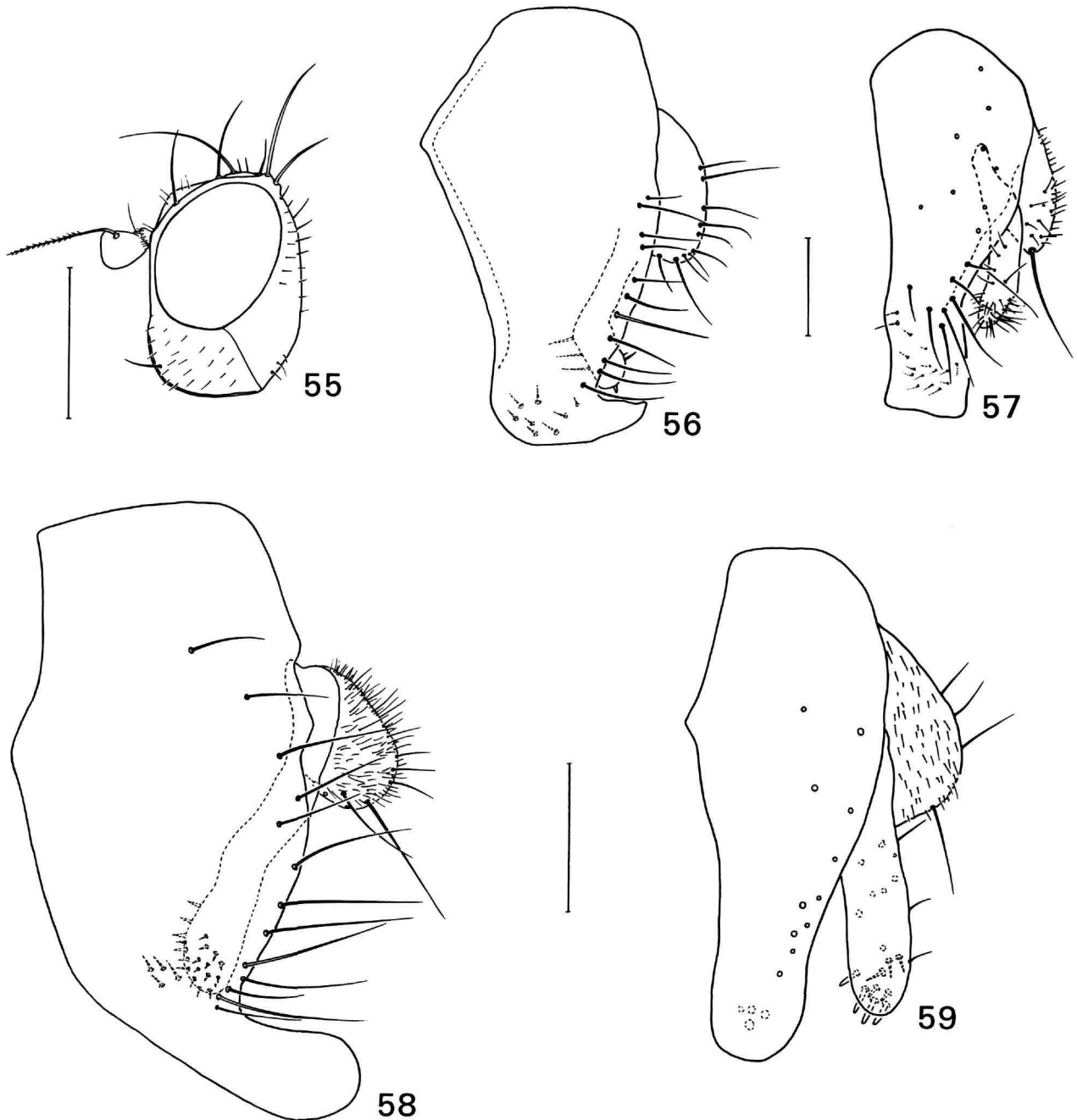

FIGURES 55-59.—Head and external male terminalia (epandrium, cercus, surstylus): 55, head of *Pelomyia crassiseta*, lateral aspect; 56, *P. crassiseta*, lateral aspect; 57, *P. crassispina*, lateral aspect; 58, *P. grisecoxa*, lateral aspect; 59, *P. melanocera*, lateral aspect. Scale bars = 0.5 mm for Figure 55, 0.1 mm for Figures 56-59.

shiny chitinous stripe along parafacial and peristomal margins; palpus yellow; clypeus with dark brown microtomentum.

Thorax: Mesonotum generally with grayish brown microtomentum; dorsal $\frac{1}{3}$ of anepisternum with brown, microtomen-

tose area; acrostichal setulae minute, in several uneven rows. Wing hyaline; costal section ratios 6.4:1.4:1.0; crossvein *bm-cu* present. Forecoxa black in base color, with grayish microtomentum, with 2 or 3 large setae in addition to a few smaller

ones; mid- and hindcoxae concolorous with forecoxa; forefemur moderately swollen, mostly with black microtomentum, posterodorsal row of setae relatively weak except for distal 3 or so, setae of posteroventral surface of normal size (typical of genus), many scattered smaller setae on remainder of posterior surface, otherwise evenly setulose; forefemoral anteroventral ctenidial comb of setae moderately strong, shorter than width of foretibia; hindfemur moderately swollen; mid- and hindfemora with black microtomentum, evenly setulose, anterior surface of midfemur with one stronger seta in middle; tibiae black, microtomentose, evenly setulose; tarsi black.

Abdomen: With uniformly grayish microtomentum, extreme posterior margins of each segment paler. Male terminalia (Figure 56): ventral lobe of epandrium curving posteriorly, hood-like, with a row of strong, stout setae on posterior margin; surstylus spatulate, curved posteriorly, armed with many short stout setae; aedeagus widely flared, covered with minute setulae, thick, pubescent, shorter than that of most species; pregonite completely fused with hypandrium; hypandrium stout in lateral view; distal portion of postgonite short, spatulate; basiphallus rounded; ejaculatory apodeme with a minute flare at extreme distal end; subepandrial sclerite narrow, rectangular. Female terminalia: cercus bearing many long, thick, spines.

TYPE MATERIAL.—The holotype male is labeled "Chile Chico[,] Lag[o]. Buenos Aires[,] Aysen, CHILE[,] 24–31 XII. 60. [24–31 Dec 1960] [L.E.] Pena/HOLOTYPE *Pelomyia crassiseta* ♂ Foster & W.N.Mathis [red label; species name and '♂ Foster &' handwritten]." The holotype is glued directly to the pin, is in excellent condition, and is deposited in the CNC.

Twenty-seven paratypes (7♂, 20♀; CNC, USNM) bear the same label data as the holotype. Other paratypes are as follows: CHILE. Aysén: Lago Buenos Aires, Chico, 24–31 Dec 1960, L.E. Peña (4♂, 10♀; CNC, USNM); Lago Buenos Aires, Puerto Ibanez, 12–15 Jan 1961, L.E. Peña (2♂, 4♀; CNC).

OTHER SPECIMEN EXAMINED.—ARGENTINA. *Neuquen:* Catan-Lil, 21 Nov 1989, S.A. Marshall (1♂; GUE).

DISTRIBUTION (Figure 60).—Neotropical: Argentina (Neuquen), Chile (Aysén).

ETYMOLOGY.—The species epithet, *crassiseta*, is of Latin derivation and alludes to the stout setae on the surstylus.

REMARKS.—The holotype specimen of this species is unusual in having the aedeagus fully extended in death. The entire aedeagus and internal copulatory apparatus, including the postgonites, basiphallus, and posterior flange of the aedeagal apodeme, are all everted.

This species is similar to *P. melanocera*, especially in structures of the male terminalia. The surstyli of both species bear stout, peg-like setae on the distal knobs; the subepandrial sclerite is reduced to a broadly U-shaped sclerite to which the surstyli firmly articulate; the aedeagus of both species is short and quite wide; and the hypandrium appears stout in lateral view because of the broad fusion of the pregonites to its ventral surface. In this species, there is a remnant of the pregonite hood,

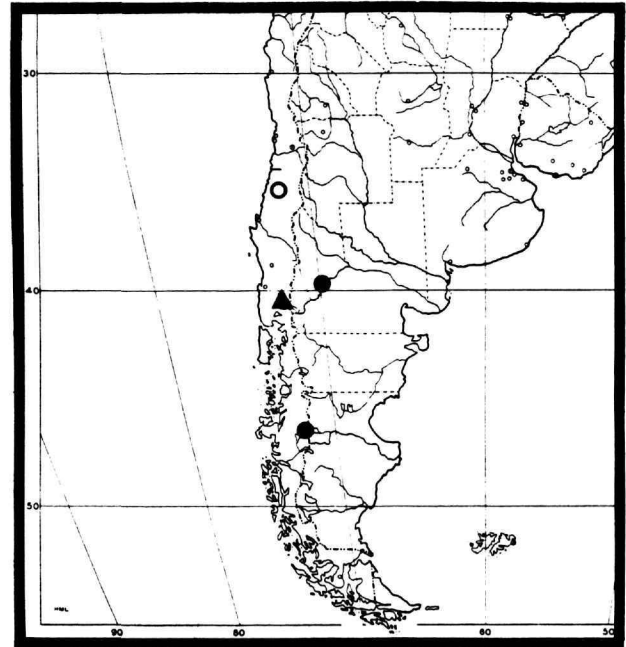

FIGURE 60.—Distribution map for *Pelomyia crassiseta* (dots), *P. grisecoxa* (open circle), and *P. melanocera* (triangle).

which is conspicuous in the subgenus *Pelomyia*. In *P. melanocera*, this hood is entirely lacking, however. Finally, the postgonites of both species have a wide spatulate posterior blade that lacks the nodulate area in the flexion zone. In this species, there is a remnant of the nodulate area, but this is surprisingly present on the pregonite hood. Both species also have crossvein bm-cu, which is lacking in most of the subfamily.

24. *Pelomyia crassiseta*, new species

FIGURES 53, 57

DIAGNOSIS.—This species is distinguished from congeners by the following combination of characters: body generally with grayish brown microtomentum dorsally, pleural sclerites grayish with anepisternum with brownish microtomentum dorsally; frons mostly yellow, brown at sides of ocellar triangle, with a few minute setulae; parafrenal setae sparse, minute; fronto-orbital setae 3, reclinate; ocellar triangle with gray microtomentum; antenna mostly brown, 1st flagellomere orange with small dark area around base of arista; oral vibrissae small, weak; gena 0.26–0.29 times eye height; acrostichal setulae minute, sparse; wing crossveins not infuscate; crossvein bm-cu at least partially present; tarsomeres of normal size; forecoxa yellow in base color with white microtomentum; mid- and hindfemora not swollen; forefemoral anteroventral ctenidial comb of setae absent.

DESCRIPTION.—Body length 2.75–2.90 mm; body with brown to brownish gray microtomentum.

Head: Ocellar triangle with gray microtomentum; frons mostly yellow, brown dorsally with a few minute setulae; parafrons with silvery microtomentum at extreme margins; frontal lunule diminutive, yellow to white; fronto-orbital setae 3; parafrontal setae minute, sparse; ocellar setae 1 pair, well developed with a few short, weak setulae; paraverticlar setae minute, convergent. Antenna mostly brown, 1st flagellomere orange with small dark area around base of arista. Gena 0.26–0.29 times eye height, with whitish microtomentum and a few minute, scattered setulae and row of peristomal setulae; face whitish; shiny chitinous stripe along parafacial and peristomal margins; palpus yellow; clypeus with dark brown microtomentum.

Thorax: Mesonotum generally with grayish brown microtomentum; dorsal 1/3 of anepisternum with brown, microtomentose area; acrostichal setulae minute, sparse, or lacking. Wing hyaline; costal section ratios 6.0:1.2:1.0; crossvein bm-cu at least partially present. Forecoxa yellow in base color, with whitish microtomentum, with 2 or 3 large setae in addition to a few smaller ones; mid- and hindcoxae gray; forefemur barely swollen, with brown microtomentum, posterodorsal row of setae relatively weak except for distal 3 or so, setae of posteroventral surface of normal strength, many scattered smaller setae on remainder of posterior surface, otherwise evenly setulose; forefemoral anteroventral ctenidial comb of setae absent; hindfemur barely swollen; mid- and hindfemora with brown microtomentum, evenly setulose, anterior surface of midfemur with 1 stronger seta in middle; tibiae mostly yellow with a brown band distally, not extended to apex, microtomentose, evenly setulose; tarsi with first 2 tarsomeres yellow, 3rd tarsomere yellow on basal 1/2, brown distally, and distal tarsomeres brown.

Abdomen: Uniformly with grayish microtomentum, extreme posterior margins of each segment paler. Male terminalia (Figure 57): ventral lobe of epandrium long, truncate ventrally, with a few weak setulae on medial surface; surstylus spatulate, setulose distally; aedeagus long, sinuous, flared distally, micro-pubescent over entire length; pregonite completely fused with hypandrium; hypandrium stout in lateral view; distal portion of postgonite short, spatulate; basiphallus rounded; ejaculatory apodeme flared normally (typical of genus); subepandrial sclerite relatively square. Female terminalia: cercus bearing many long, thick, spines.

TYPE MATERIAL.—The holotype male is labeled "ARGENTINA [INA.] Jujuy [.] La Quiac [.] 23.X.68. [23 Oct 1968] 3500m. L.E. Pena/HOLOTYPIC *Pelomyia crassispina* ♂ Foster & W.N. Mathis [red label; species name and '♂ Foster &' handwritten]." The holotype is glued directly to the pin, in an excellent condition (abdomen removed and dissected, parts in an attached microvial), and is deposited in the CNC.

Paratypes are as follows: ARGENTINA: *Jujuy:* Abrolaite (85 km S Abra Pampa, 3650 m), 29 Oct 1968, L.E. Peña (1♀; CNC); Coyaquayma (7 km S Mina Perquitas; 4100 m), 4 Nov 1968, L.E. Peña (1♀; CNC).

DISTRIBUTION (Figure 53).—Neotropical: Argentina (Jujuy).

ETYMOLOGY.—The species epithet, *crassispina*, is of Latin derivation and alludes to the stout, spine-like setae on the cercus of this species.

REMARKS.—This species shares with *P. melanocera* and *P. crassiseta* the *Tethina*-like hypandrium and pregonite configuration. The pregonites are fused with the hypandrium and appear to be the ventral floor of the hypandrium. That they are pregonite remnants is evidenced by the few remaining setae on the ventromedial surface. This appears to be a case of convergence as this configuration occurs in both subfamilies (Pelomyiinae and Tethininae).

25. *Pelomyia grisecoxa*, new species

FIGURES 58, 60

DIAGNOSIS.—This species is distinguished from congeners by the following combination of characters: body with grayish brown microtomentum; frons mostly brown, slightly orange toward antennae; parafrontal setae few, minute; fronto-orbital setae 2, reclinate; antenna mostly brown with medial surface of 1st flagellomere slightly orange; oral vibrissae weakly developed but distinct; gena approximately 0.34 times eye height; mesonotum grayish brown; dorsal 1/3 of anepisternum brown, remainder with gray microtomentum; remainder of pleural surfaces mostly with gray microtomentum; acrostichal setulae few, minute, in 3 scattered rows; wing crossveins not infuscate; forecoxa gray in base color; mid- and hindfemora not swollen, entirely brown; tibiae entirely gray; forefemoral anteroventral ctenidial comb of setae weak but distinct, shorter than width of foretibia; tarsomeres of normal size.

DESCRIPTION.—Length of head and thorax 1.30 mm; body generally with grayish brown microtomentum.

Head: Ocellar triangle with brown microtomentum; frons mostly brown, orange toward antennal bases, extreme margins with silvery microtomentum; frontal lunule yellow; parafrontal setulae few, minute; ocellar seta 1, well developed, another 2 or 3 minute ocellar setulae; paraverticlar setae short, weak, separated by approximate width of ocellar triangle, convergent. Antenna mostly brown, only medial surface of 1st flagellomere slightly orange. Gena approximately 0.34 times eye height, with whitish microtomentum, bearing many minute, scattered setulae; shiny chitinous stripe along parafacial and peristomal margins; palpus yellow; clypeus gray.

Thorax: Mesonotum mostly with brown microtomentum and with gray stripe along line of dorsocentral setae; acrostichal setulae few, minute, in 3 scattered rows; dorsal 1/3 of anepisternum with brown microtomentum, remainder with gray microtomentum; remainder of pleural surfaces mostly with gray microtomentum. Wing hyaline; costal section ratios 4.9:1.3:1.0; crossvein bm-cu incomplete. Forecoxa gray in base color, with silvery microtomentum, with 2 or 3 large setae in addition to a few smaller ones; mid- and hindcoxae concolorous with forecoxa; forefemur moderately swollen, with gray

microtomentum and row of 6–8 strong setae on both postero-dorsal and posteroventral surfaces, distal 2 or 3 usually strongest, many scattered smaller setae on remainder of posterior surface, otherwise evenly setulose; forefemoral anteroventral ctenidial comb of setae weak, shorter than width of foretibia; hindfemur moderately swollen; mid- and hindfemora with gray microtomentum, evenly setulose, anterior surface of midfemur with one stronger seta in middle; tibiae with gray microtomentum, evenly setulose; tarsi gray.

Abdomen: With gray microtomentum. Male terminalia (Figure 58): ventral lobe of epandrium directed posteriorly, spatulate; anterior margin bare, posterior margin bearing several setulae; surstylus long, spatulate, bearing many short, well-developed setulae distally; aedeagus thick, pubescent; pregonite distinct but fused with hypandrium, pointed, partly fused with postgonite; hypandrium moderately wide in lateral view; distal portion of postgonite widely spatulate; basiphallus long, pointed, triangulate; ejaculatory apodeme not flared; subepandrial sclerite narrow, rectangular. Female unknown.

TYPE MATERIAL.—The holotype male, the only known specimen of this species, is labeled “El Coigo, Curico, CHILE. Jan. 1961[,] L.E. Peña/HOLOTYPIC Pelomyia grisecoxa ♂ Foster & W.N. Mathis [red label; species name and ‘♂ Foster &’ handwritten].” The holotype is glued directly to the pin, is in good condition (abdomen removed, dissected, structures in an attached microvial; some setae broken, right wing removed and glued to pin above specimen), and is deposited in the CNC.

DISTRIBUTION (Figure 60).—Neotropical: Chile (Curicó).

ETYMOLOGY.—The species epithet, *grisecoxa*, is of Latin derivation and alludes to the gray forecoxa of this species.

26. *Pelomyia melanocera*, new species

FIGURES 59, 60

DIAGNOSIS.—This species is distinguished from congeners by the following combination of characters: body with generally brown microtomentum dorsally, pleural sclerites with gray microtomentum; frons unicolorous with ocellar triangle, dark, infuscate brown, bearing few minute setulae; parafacial setae present as several minute scattered hairs; fronto-orbital setae 2, reclinate; antenna entirely black; oral vibrissae minute, weak; gena 0.5 times eye height; acrostichal setulae minute, scattered; crossvein bm-cu variable, present but incomplete; wing crossveins not infuscate; tarsomeres of normal size; forecoxa black in base color with whitish microtomentum; mid- and hindfemora not swollen; forefemoral anteroventral ctenidial comb of setae weak, sparse, shorter than width of foretibia.

DESCRIPTION.—Body length 2.75–3.15 mm; body generally with brown microtomentum.

Head: Ocellar triangle concolorous with frons and parafrons, dark infuscate with brown to black microtomentum, only extreme margin of parafrons gray; ocellar setae 1 pair, strong, another pair of minute ocellar setulae; paravertical setae minute, widely separated, and convergent. Frontal lunule, face, and gena pale brown. Antenna entirely black. Gena 0.5 times

eye height, bearing many minute, scattered setulae; shiny chitinous stripe along parafacial and peristomal margins; palpus yellow; clypeus with silvery gray microtomentum.

Thorax: Generally with grayish microtomentum on pleural sclerites; dorsal 1/3 of anepisternum with brown, microtomentose band; acrostichal setulae minute, in 2 uneven rows. Wing hyaline; costal section ratios 6.4:1.1:1.0; crossvein bm-cu present but incomplete. Forecoxa black in base color, with grayish white microtomentum, with 2 or 3 large setae in addition to a few smaller ones; mid- and hindcoxae concolorous with forecoxa; forefemur barely swollen, with black microtomentum and bearing a row of 6–8 weak setae on posterodorsal surface, posteroventral row sparse but stronger, many scattered smaller setae on remainder of posterior surface, otherwise evenly setulose; forefemoral anteroventral ctenidial comb of setae weak, sparse, shorter than width of foretibia; hindfemur barely swollen; mid- and hindfemora with black microtomentum, evenly setulose with anterior surface of midfemur bearing 1 stronger seta in middle; tibiae black, evenly setulose; tarsi black.

Abdomen: Dorsum with brownish microtomentum, lateral surfaces with gray microtomentum; extreme posterior margin of each segment paler. Male terminalia (Figure 59): ventral lobe of epandrium simple, spatulate, narrowing only slightly, margins bare, a few stout setae medially; surstylus spatulate, margins bare, with several enlarged, peg-like setae on distal medial surface; aedeagus thick, pubescent; pregonite completely fused with hypandrium, bearing few remnant setulae; hypandrium in lateral view stout; distal portion of postgonite spatulate; basiphallus rounded; ejaculatory apodeme moderately flared; subepandrial sclerite simple, plate-like, narrow, rectangular. Female terminalia: cercus bearing several thick, stout spines.

TYPE MATERIAL.—The holotype male is labeled “CHILE. Osorno Pr. Volcan Puyhue[,] 1400 m. elev.[,] 4 Feb 1978[,] WMathis/HOLOTYPIC Pelomyia melanocera ♂ Foster & W.N.Mathis USNM [red label; species name and ‘♂ Foster &’ handwritten].” The holotype is double mounted (mounted in a block of white plastic), is in excellent condition, and is deposited in the USNM. Fifteen paratypes (1♂, 14♀; USNM) bear the same label data as the holotype.

DISTRIBUTION (Figure 60).—Neotropical: Chile (Osorno).

ETYMOLOGY.—The species epithet, *melanocera*, is of Greek derivation and alludes to the black antenna.

REMARKS.—Structures of the male terminalia of this species exhibit numerous unique features: the basiphallus is enlarged and somewhat circular in shape; the aedeagus, although clearly stout and thickly pubescent, is shorter relative to its width than for other species of *Pelomyia*; the flexion zone of the postgonites lacks the peculiar nodulate thickening; the subepandrial sclerite is reduced to a single, somewhat thickened and moderately U-shaped sclerite; and the hypandrium more closely resembles comparable structures in species of *Tethina* in being wide in lateral view with the pregonites reduced and fused with it (only a few setulae remain on the pregonites).

27. *Pelomyia* species

DIAGNOSIS.—This species is distinguished from congeners by the following combination of characters: body length 1.85 mm; thorax with grayish microtomentum; abdomen subshiny, with pale gray microtomentum.

Head: Frons yellowish orange, darker near ocellar triangle; parafrenal setulae minute or absent; fronto-orbital setae 2, reclinate; antenna mostly brownish yellow; oral vibrissae moderately developed. Gena about 0.40 times eye height.

Thorax: Mesonotal and pleural surfaces with gray, even microtomentum; acrostichal setulae few, minute, in 2 scattered rows. Wing crossveins not infuscate. Forecoxa yellowish in base color; fore- and hindfemora not swollen, entirely grayish brown; foretibia brown on distal $\frac{2}{3}$, yellow basally; mid- and hindtibia pale brown; forefemoral anteroventral ctenidial comb of setae apparently absent; tarsomeres of normal size.

Abdomen: Brownish with pale gray microtomentum, subshiny. Male unknown. Female cercus bearing some well-developed setae.

SPECIMEN EXAMINED.—CHILE. *Coquimbo*: Chañaral de Aceituna, 12 Oct 1958, L.E. Peña (1♀; CNC).

REMARKS.—This species is not named herein because only one female is known. Based on the presence of two fronto-orbital setae and of crossvein bm-cu, we suggest that this species is more closely related to the *melanocera* group. Without more specimens, especially males, we are uncertain as to its species group.

Genus *Masoniella* Vockeroth

Masoniella Vockeroth, 1987:1075 [nomen nudum; type species: *Masoniella richardsi* Vockeroth, 1987, by original designation]; 1995:732 [validation].—Mathis and Munari, 1996:13 [world catalog].

DIAGNOSIS.—*Masoniella* is distinguished from other genera of Tethinidae by the following combination of characters.

Head: Round, as high as long; gena 0.08–0.20 times eye height, with scattered minute setulae over entire surface or bare except for peristomal row in one species; peristomal margin with shiny chitinous stripe; labellum short; eye round, facets increasing in size anteriorly; fronto-orbital setae 1 or 2; parafrenal setae minute to absent; 1 pair of ocellar setae; true postvertical setae absent; paraverticilar setae minute, convergent; oral vibrissae usually weak, small; antenna porrect.

Thorax: Usually with brownish microtomentum but varying to shiny brown (when shiny, mesonotum is dark brown), pleural surfaces and scutellum pale brown; acrostichal setulae minute, in 2 or 4 uneven rows; disk of scutellum bare. Wing lacking crossvein bm-cu. Forefemur in both sexes with anteroventral ctenidial comb composed of 6–8 moderately strong, short, black setae.

Abdomen: Entirely shiny brown. Male terminalia (Figures 61, 62, 64–71): epandrium with ventrolateral processes, long, widely spatulate to pointed, often with strong setae or setulae on inner or outer surface or both; true surstylus typically

straight, positioned along posterior margin of epandrium, laterad to cercus, articulated with subepandrial sclerite; surstylar armature as many minute setulae; an anterior lobe clearly arising from subepandrial sclerite in one species; subepandrial sclerite strongly sclerotized in an X-shaped configuration, articulated with the hypandrium anteriorly and with the surstylus posteriorly; cercus usually about $\frac{1}{2}$ length of surstylus, pubescent and bearing many long fine setae, apical seta longest; hypandrium rather large, semicircular, 2-armed with arms separated posteriorly and articulated with subepandrial sclerite and epandrium, arms fused with aedeagal apodeme anteriorly; hypandrial apodeme absent. Internal copulatory apparatus: basiphallus rounded or triangular, long, tapered, articulated with posterior apex of aedeagal apodeme; opening in center of basiphallus allows ejaculatory duct to pass through to the aedeagus; pregonites usually fused to hypandrium, sometimes evident only by the presence of short setae; postgonites long, pointed or spatulate posteriorly, with a scaly or nodulate thickening centrally, can be flexed fully 90° or more at this thickening, articulate with aedeagal apodeme just posterior to fusion point of hypandrium with aedeagal apodeme; aedeagal apodeme long, rod-like; ejaculatory apodeme moderately to widely flared; aedeagus long, strap-like, with dense micropubesence along entire length on dorsal surface, usually long, tapered toward apex. Female terminalia: cercus lacking thick, blunt spines; spermathecae as in *Pelomyia*.

DISCUSSION.—Species of *Masoniella* are generally characterized by their small, delicate habitus, rarely longer than 2.0 mm and never more than 2.50 mm. Except for *M. argentinaensis*, the species have the thorax and/or abdomen quite shiny, bearing sparse or no microtomentum. In characters of the male terminalia, species of *Masoniella* generally share a large, deep hypandrium, large pregonites, and a short, spatulate, or absent distal portion of the postgonite. Two species, *M. flabella* and *M. advena*, have only a remnant of the pregonite hood, which is also distinct in the genus *Pelomyia*. The other four species of *Masoniella* lack the hood entirely.

Vockeroth (1987) described *Masoniella* for a single new species, *M. richardsi*, on the basis of two fronto-orbital setae, the extremely narrow gena, and presumably the structures of the male genitalia, which display an anterior lobe that is unique within the subfamily. Our study reveals that *Masoniella* shares many of the synapomorphies of *Pelomyia*, including the shiny chitinous stripe along the peristomal margin and the peculiar, nodulate, flexible postgonites. Although *M. richardsi* lacks the scattered genal setulae found in *Pelomyia*, indeed in most species of Pelomyiinae, we believe this is a secondary reduction of these setae to the peristomal margin. The gena is extremely narrow for a tethinid (0.08 times the eye height); thus, reduction in the number of genal setulae may be the result of a general reduction of the gena. These setulae are not directed dorsally nor are they as strong as those in the subfamily Tethininae.

At the time of its discovery, *M. richardsi* was unique, relative to other tethinids, in having a small, shiny body. All other species of the family then known were completely invested with

fine microtomentum. Our study has revealed four new species, all from high altitudes in the Andes Mountains, that also display a diminutive size and have at least the abdomen completely shiny. Two species, *M. advena* and *M. flabella*, have a sparse dusting of microtomentum on the thorax, but their overall appearance is shiny, as in *M. richardsi*. These five species plus *M. argentinaensis* are herein grouped in the genus *Masoniella* on the basis of the diminutive body (and all except *M. argentinaensis* are shiny).

NOTES ON THE ORIGIN OF THE ANTERIOR SURSTYLAR LOBE.—The anterior lobe (or anterior surstylus) has apparently evolved more than once in the Tethinidae, occurring in both the Pelomyiinae (*Masoniella*) and in the Tethininae (*Afrotethina* Munari, *Pseudorhichnoessa* Malloch, *Dasyrhichnoessa* Hendel, *Plesiotethina* Munari (provisionally placed in this subfamily), and apparently in one species of *Tethina*). Examination of this structure in *Masoniella richardsi* Vockeroth (Figure 69) has

clearly revealed it to be an outgrowth of the subepandrial sclerite. This is the first direct evidence that the anterior lobe is not the result of a bifurcation and eventual splitting of the true, or posterior, surstylus. It appears to have evolved independently of the surstylus.

In *Dasyrhichnoessa*, the anterior lobe articulates with the anterior margin of the epandrium and appears to be completely disassociated with the subepandrial sclerite, whereas in one species of *Afrotethina* the anterior lobe articulates only with the true surstylus, again completely disassociated from the subepandrial sclerite. Rather than postulate the development of an entirely new structure in the Tethininae, we instead suggest, based on the evidence of *M. richardsi*, that the anterior lobe of these taxa arose from the subepandrial sclerite as well, eventually separated from it, and became fused with the epandrium or the surstylus. A detailed analysis of this and other character complexes of the Tethininae will be provided in a future publication.

Key to Species of *Masoniella* Vockeroth

1. Fronto-orbital setae 2 2
Fronto-orbital seta 1 4
2. Thorax entirely shiny 32. *M. richardsi* Vockeroth
Thorax with brown microtomentum 3
3. Antenna mostly brown; vein R_{2+3} ending in costa before wing apex
..... 30. *M. delicata*, new species
Antenna mostly orange; vein R_{2+3} ending in costa behind wing apex
..... 33. *M. spatulata*, new species
4. Thorax with brown microtomentum 29. *M. argentinaensis*, new species
Thorax entirely shiny brown 5
5. Femora brown; gena high, at least 0.25 times eye height
..... 28. *M. advena*, new species
Mid- and hindfemora yellow; gena moderately to very narrow, approximately 0.10–
0.20 times eye height 31. *M. flabella*, new species

28. *Masoniella advena*, new species

FIGURES 61, 72

DIAGNOSIS.—This species is distinguished from congeners by the following combination of characters: body entirely shiny brown; frons mostly yellow, brown near sides of ocellar triangle, with a few minute setulae; parafrontal setae sparse, minute; fronto-orbital seta 1, reclinate; ocellar triangle brown, somewhat shiny; antenna mostly orange with small dark area near base of arista; oral vibrissae small, weak; gena 0.25 times eye height; acrostichal setulae minute, sparse or apparently absent; wing crossveins not infuscate; tarsomeres of normal size; forecoxa yellow in base color with white microtomentum; mid- and hindfemora not swollen; forefemoral anteroventral ctenidial comb of setae short, weak, individual setae more widely separated than in other species.

DESCRIPTION.—Body length 1.85 mm; body shiny brown with a light dusting of microtomentum.

Head: Ocellar triangle shiny brown with some microtomentum; frons mostly yellow, brown dorsally with a few minute setulae; parafrons with silvery microtomentum at extreme margins; frontal lunule diminutive, yellow to white; fronto-orbital seta 1; parafrontal setae minute, sparse; ocellar seta 1, well developed, with a few short, weak setulae; paravertic setae minute, convergent. Antenna mostly orange, 1st flagellomere orange with small dark area around base of arista. Gena 0.25 times eye height, with whitish microtomentum and a few minute, scattered setulae and a row of peristomal setulae; face whitish; shiny chitinous stripe along parafacial and peristomal margins; palpus white; clypeus with pale brown microtomentum.

Thorax: Mesonotum entirely shiny brown with a light microtomentum; acrostichal setulae minute, sparse, or lacking. Wing hyaline; costal section ratios 6.9:1.8:1.0. Forecoxa yellow in base color, with whitish microtomentum, with 2 or 3 large setae in addition to a few smaller ones; mid- and hind-

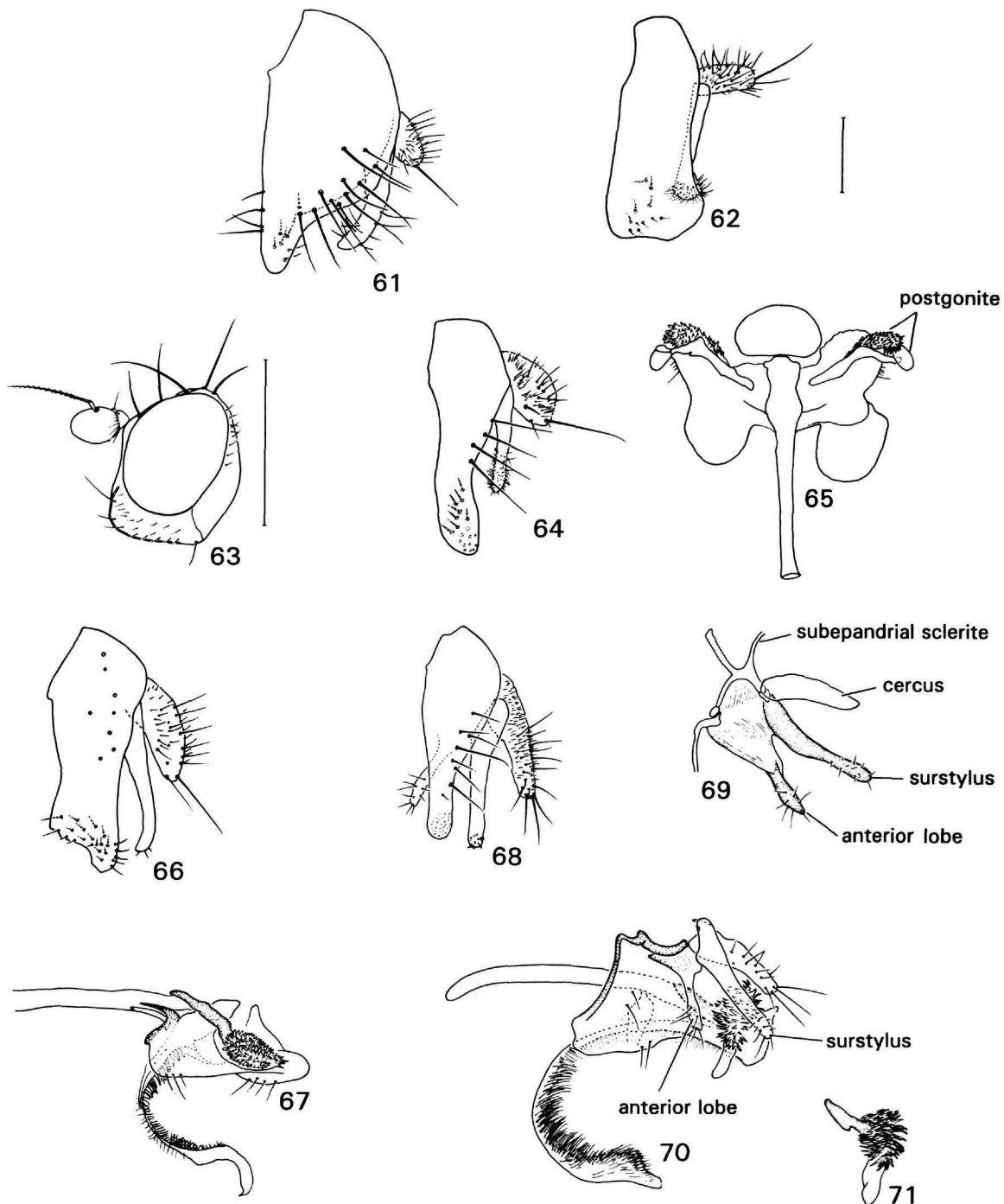

FIGURES 61-71.—External male terminalia (epandrium, cercus, surstylus), unless specified otherwise, for several species of *Masoniella*: 61, *M. advena*, lateral aspect; 62, *M. argentinaensis*, lateral aspect; 63, head of *M. delicata*, lateral aspect; 64, *M. delicata*, lateral aspect; 65, internal copulatory apparatus of *M. delicata*, dorsal aspect; 66, *M. flabella*, lateral aspect; 67, internal copulatory apparatus of *M. flabella*, lateral aspect; 68, *M. richardsi*, lateral aspect; 69, subepandrial sclerite, anterior lobe, surstylus, and cercus of *M. richardsi*, flattened aspect; 70, internal copulatory apparatus of *M. richardsi*, lateral aspect; 71, postgonite of *M. richardsi*, lateral aspect. Scale bars = 0.1 mm (scale bar to right of Figure 63 applies only to that figure; scale bar in upper right corner applies to all others).

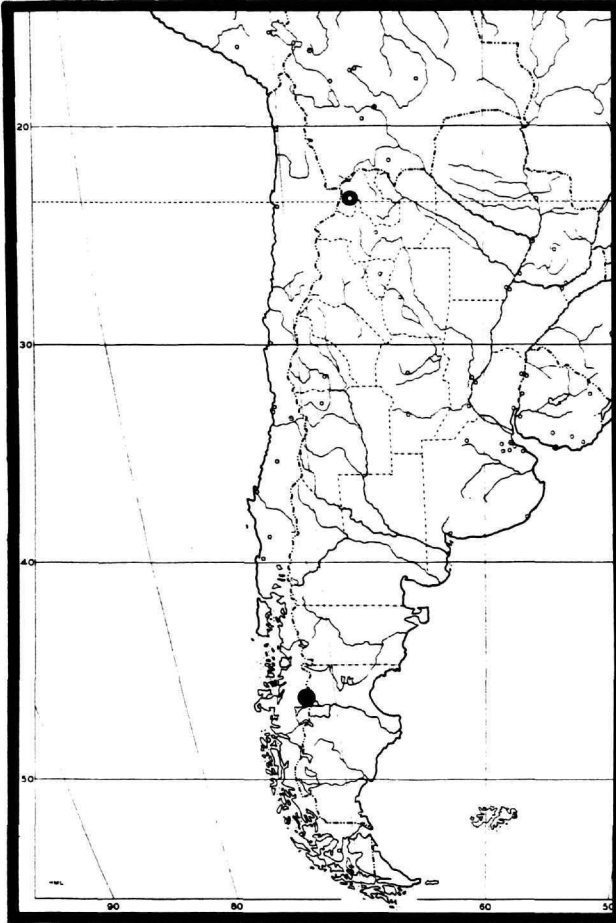

FIGURE 72.—Distribution map for *Masoniella advena* (open circle) and *M. spatulata* (dot).

coxae brown with grayish microtomentum; forefemur barely swollen, brown, subshiny, with posterodorsal and posteroventral rows of setae relatively weak but distinct, many scattered smaller setae on remainder of posterior surface, otherwise evenly setulose; forefemoral anteroventral ctenidial comb of setae weak, relatively sparse, shorter than width of foretibia; hindfemur barely swollen; mid- and hindfemora brown, subshiny, evenly setulose, anterior surface of midfemur with 1 stronger seta in middle; foretibia brown, mid- and hindtibiae dark yellow, microtomentose, evenly setulose; foretarsus brown, mid- and hindtarsi with basal 3 tarsomeres yellow, remainder brown.

Abdomen: Uniformly shiny brown. Male terminalia (Figure 61): ventral lobe of epandrium long, tapered to a rounded point ventrally, bearing a few setulae on medial surface; surstylus spatulate, sparsely setulose; aedeagus long, sinuous, flared distally, micropubescent over entire length; pregonite distinct but short, rounded, fused with hypandrium at base; hypandrium

narrow in lateral view; distal portion of postgonite short, rounded, spatulate; basiphallus long, pointed, triangular; ejaculatory apodeme flared normally. Female unknown.

TYPE MATERIAL.—The holotype male is labeled “ARGENT[INA.] Jujuy[:] Agua Caliente[:] NE. Guemes, 1100m. 18-19.X.68. [18-19 Oct 1968] [L.E.] Pena/HOLOTYP E Masoniella advena ♂ Foster & W.N.Mathis [red label; species name and ‘♂ Foster &’ handwritten].” The holotype is glued directly to the pin, is in good condition (some setae, especially on head, broken and/or missing), and is deposited in the CNC. One male paratype (CNC) bears the same label data as the holotype.

DISTRIBUTION (Figure 72).—Neotropical: Argentina (Jujuy).

ETYMOLOGY.—The species epithet, *advena*, is of Latin derivation, meaning visitor, stranger, or intruder, and it alludes to the odd or transitional status of this species.

REMARKS.—This species, like *M. flabella*, closely resembles *M. richardsi* in having an entirely shiny body with delicate shiny legs. It shares with *M. flabella* a reduction in the number of fronto-orbital setae to a single pair, whereas other species of the genus retain two pairs. *Masoniella advena* is clearly a transitional species between the genera *Pelomyia* and *Masoniella*. It shares the apomorphic shiny, diminutive body size and legs of *Masoniella* while having many of the characteristics of the male genitalia of *Pelomyia*. It has the thick, densely pubescent aedeagus; the shape of the postgonites is virtually identical to *Pelomyia*; and there is a remnant of the hood of pregonite origin over the basiphallus. The basiphallus also shows the same longer triangular form of *Pelomyia*.

29. *Masoniella argentinaensis*, new species

FIGURE 62

DIAGNOSIS.—This species is distinguished from congeners by the following combination of characters: body with generally brown microtomentum, pleural sclerites with some grayish, microtomentose areas; frons dark yellow, with a few minute setulae; parafrontal setae present as several minute scattered hairs; fronto-orbital seta 1, reclinate; antenna mostly brown, orange on distal portion of 1st flagellomere; oral vibrissae short, moderately strong; gena 0.20 times eye height; acrostichal setulae minute, in 2 uneven rows; wing crossveins not infuscate; tarsomeres of normal size; forecoxa white; mid- and hindfemora not swollen; forefemoral anteroventral ctenidial comb of setae minute, shorter than width of foretibia.

DESCRIPTION.—Body length 1.65 mm; body with brown microtomentum, pleural sclerites with some grayish areas.

Head: Ocellar triangle with brown microtomentum; frons dark yellow, parafrons with silvery gray microtomentum; frontal lunule white; parafrontal setulae few, minute; ocellar setae 1 pair, strong, additional pair of weak ocellar setulae; paravertic setae minute, widely separated, and convergent. Antenna mostly brown, orange on distal portion of 1st flagellomere. Gena 0.20 times eye height, with gray microtomentum, bearing minute, scattered setulae; shiny chitinous stripe along

parafacial and peristomal margins; palpus yellow; clypeus with brown microtomentum.

Thorax: Mesonotum generally with brown microtomentum, pleural sclerites with some grayish areas. Wing hyaline; costal section ratios 6.0:1.66:1.0. Forecoxa white in base color, with white microtomentum, with 2 or 3 large setae in addition to a few smaller ones; mid- and hindcoxae with yellow microtomentum; forefemur moderately swollen, with brown microtomentum and bearing a row of 6–8 or more strong setae on both posterodorsal and posteroventral surfaces, distal 2 or 3 strongest, many scattered smaller setae on remainder of posterior surface, otherwise evenly setulose; forefemoral anteroventral ctenidial comb of setae with setae minute, shorter than width of foretibia; hindfemur barely swollen; mid- and hindfemora with yellow microtomentum, evenly setulose, anterior surface of midfemur with one stronger seta in middle; foretibia and tarsus brown; mid- and hindtibiae with yellow microtomentum, evenly setulose; mid- and hindtarsi yellow.

Abdomen: Uniformly with brown microtomentum. Male terminalia (Figure 62): ventral lobe of epanthrium widening ventrally, approximately twice as wide as dorsum of epanthrium, margins bare, a few scattered setae on medial surface; surstylus wider distally than basally, straight, bearing short setae on distal portion; cercus normal; aedeagus thick, pubescent; pregonite indistinct, fused with hypandrium; hypandrium stout in lateral view; distal portion of postgonite short, rounded, spatulate, simple, lacking nodulate thickening in middle; basiphallus long, pointed, triangular; ejaculatory apodeme moderately flared. Female unknown.

TYPE MATERIAL.—The holotype male is labeled "ARGENTINA[,] Coll. R.C. Shannon/HOLOTYPE *Masoniella argentinaensis* ♂ Foster & W.N.Mathis USNM [red label; species name and '♂ Foster &' handwritten]." The holotype is double mounted (minuten in a fibrous white block), is in excellent condition (abdomen removed, dissected, and placed in glycerin in a microvial), and is deposited in the USNM. One male paratype bears the same label data as the holotype (USNM).

DISTRIBUTION.—Neotropical: Argentina.

ETYMOLOGY.—The species epithet, *argentinaensis*, is a Latin adjective, referring to the country where the type series was collected.

REMARKS.—This species is placed in *Masoniella* primarily because of its smooth, delicate overall habitus and broad hypandrium found in other species of the genus. Unlike other species of *Masoniella*, however, it has a completely microtomentose body.

30. *Masoniella delicata*, new species

FIGURES 63–65, 73

DIAGNOSIS.—This species is distinguished from congeners by the following combination of characters: body brown; thorax with brown microtomentum; abdomen shiny black; frons

orange; parafacial setae few, minute; fronto-orbital setae 2, anterior seta about $\frac{1}{3}$ length of posterior seta, both reclinate; antenna mostly brown with 1st flagellomere orange medially and on margins; oral vibrissae short, moderate strength; gena narrow, 0.10 times eye height; acrostichal setulae minute, in 2 scattered rows; wing crossveins not infuscate; tarsomeres of normal size; forecoxa white in base color; mid- and hindfemora not swollen, yellow; forefemoral anteroventral ctenidial comb of setae minute but setae numerous, evenly spaced, and of even height, shorter than width of foretibia.

DESCRIPTION.—Body length 1.65–1.95 mm; thorax uniformly with brownish microtomentum; abdomen black.

Head (Figure 63): Ocellar triangle with brown microtomentum; frons orange, parafrons with brown microtomentum, extreme margins whitish; frontal lunule silvery, parafacial setulae few, minute; ocellar setae 1 strong pair, additional 2 or 3 minute ocellar setulae; paraverticillae minute, widely separated, and convergent. Antenna mostly brown, only part of medial surface of 1st flagellomere orange. Gena 0.10 times eye height, with yellow to brown microtomentum and bearing many minute, scattered setulae; shiny chitinous stripe along parafacial and peristomal margins; palpus yellow; clypeus with brown microtomentum.

Thorax: Mesonotum uniformly with brown microtomentum. Wing hyaline; costal section ratios 6.5:2.0:1.0. Forecoxa white in base color, with white microtomentum, with 2 or 3 large setae in addition to a few smaller ones; mid- and hindcoxae with yellow microtomentum; forefemur moderately swollen, mostly brown, extreme base white, microtomentose, with a row of 6–8 or more strong setae on both posterodorsal and posteroventral surfaces, distal 2 or 3 strongest, many scattered smaller setae on remainder of posterior surface, otherwise evenly setulose; forefemoral anteroventral ctenidial comb of setae minute but numerous, distinctly evenly spaced and of even height, shorter than width of foretibia; hindfemur barely swollen; mid- and hindfemora with yellow microtomentum, evenly setulose, anterior surface of midfemur with one stronger seta in middle; foretibia and tarsus brown; mid- and hindtibiae with yellow microtomentum, evenly setulose; mid- and hindtarsi yellow.

Abdomen: Uniformly shiny black. Male terminalia (Figures 64, 65): ventral lobe of epanthrium slightly narrowed medially, margins bare, four long setae on posterior midmargin; surstylus narrower distally than basally, straight, bearing many short setae on distal portion; cercus broadly rounded; aedeagus thick, pubescent, with a distal lobe; pregonite distinct but short, fused with hypandrium at base; hypandrium stout in lateral view; distal portion of postgonite short, rounded, spatulate; basiphallus long, pointed, triangular; ejaculatory apodeme widely flared. Female terminalia: cercus appearing fused.

TYPE MATERIAL.—The holotype male is labeled "7 [written over 'IX'] X 1965 [7 Oct 1965,] Yacango[,] MOQUEGUA, PERU 207 Coll. J.C.Hitchcock, Jr. ['207' handwritten]/HOLO-

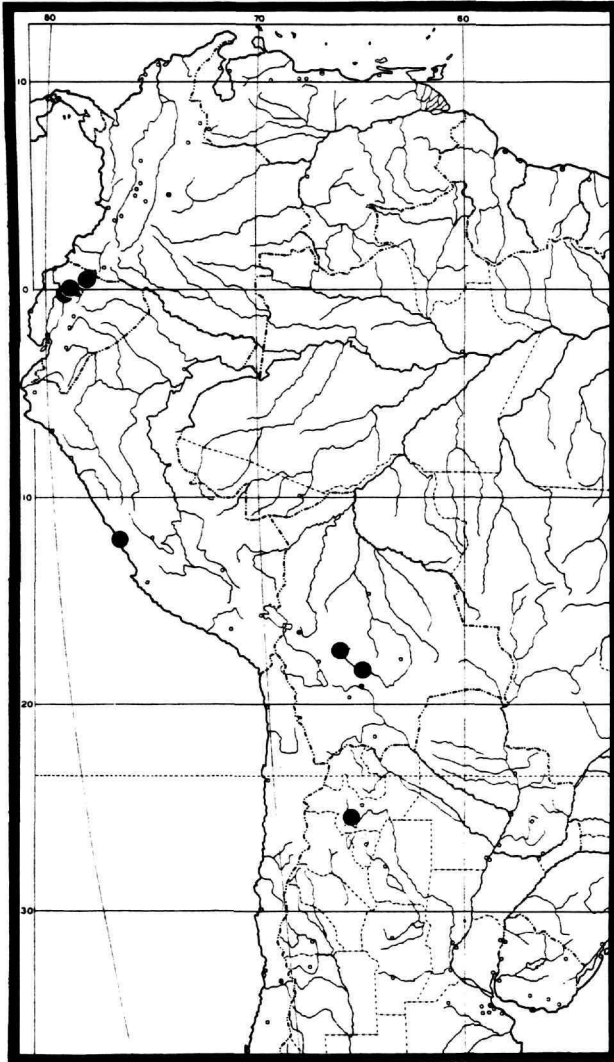

FIGURE 73.—Distribution map for *Masoniella delicata* (dots).

TYPE *Masoniella delicata* ♂ Foster & W.N.Mathis USNM [red label; species name and '♂ Foster &' handwritten]. The holotype is double mounted (mounted in a rectangular block of cork), is in good condition (right wing missing, eyes somewhat collapsed), and is deposited in the USNM.

Fifteen paratypes (12♂, 3♀; USNM) bear the same locality data (PERU. *Moquegua*: Yacango (17°06'S, 70°52'W)) as the holotype. Other paratypes are as follows: ARGENTINA. *Salta*: Palo Pintado (N San Carlos; 1900 m), 6 Oct 1968, L.E. Peña (1♂, 1♀; CNC); Rio San Lucas (N San Carlos; 1800 m), 5–6 Oct 1968, L.E. Peña (1♀; CNC).

BOLIVIA. *Cochabamba*: Cochabamba (17°23.3'S, 65°07'W; 2610 m), 25 Mar 2001, A. Freidberg (1♂; USNM).

Santa Cruz: Pampa Grande (swamp), 2 Oct 1996, Bettella and Rossi (2♂; GUE).

ECUADOR. *Ibarra*: Taguando River (1650–1900 m), 9 Jun 1965, L.E. Peña, (1♂, 1♀; CNC). *Napo*: Río Pisque (10 km N Guailabamba), 26 Feb 1983, M.J. Sharkey (1♂, 1♀; GUE). *Pichincha*: Pichincha (1650 m), 6–7 Jun 1965, L.E. Peña (1♀; CNC).

PERU. *Lima*: Lima, Jul 1914, H.S. Parish (1♀; USNM).

DISTRIBUTION (Figure 73).—Neotropical: Argentina (Salta), Bolivia (Cochabamba, Santa Cruz), Ecuador (Ibarra, Napo, Pichincha), Peru (Lima, Moquegua).

ETYMOLOGY.—The species epithet, *delicata*, is a Latin adjective and alludes to the generally delicate shape of this species.

31. *Masoniella flabella*, new species

FIGURES 66, 67, 74

DIAGNOSIS.—This species is distinguished from congeners by the following combination of characters: body entirely shiny brown, thorax with a light dusting of microtomentum; frons mostly yellow, dorsal ½ concolorous with ocellar triangle, with a few minute setulae; parafrontal setae sparse, minute; fronto-orbital seta 1, reclinate; ocellar triangle shiny brown; antenna mostly orange with dark area near base of arista; oral vibrissae small, weak; gena 0.10–0.20 times eye height; acrostichal setulae minute, sparse; wing crossveins not infuscate; tarsomeres of normal size; forecoxa white in base color with white microtomentum; mid- and hindfemora not swollen; forefemoral anteroventral ctenidial comb of setae short, individual setae relatively strong.

DESCRIPTION.—Body length 1.85–2.50 mm; body shiny brown with a light dusting of microtomentum.

Head: Ocellar triangle with shiny brown microtomentum only in area between ocelli; frons mostly yellow, concolorous with ocellar triangle dorsally, with a few minute setulae; parafrons with silvery microtomentum at extreme margins; frontal lunule diminutive, yellow; fronto-orbital seta 1; parafrontal setae minute, sparse; ocellar seta 1, well developed, with a few short, weak setulae; paraverticral setae minute, convergent. Antenna mostly orange, 1st flagellomere orange with small dark area around base of arista. Gena 0.10–0.20 times eye height, with whitish microtomentum and bearing a few minute, scattered setulae and a row of peristomal setulae; face whitish; shiny chitinous stripe along parafacial and peristomal margins; palpus white; clypeus yellow.

Thorax: Mesonotum entirely shiny brown with a light microtomentum; acrostichal setulae lacking or minute, sparse. Wing hyaline; costal section ratios 6.5:1.5:1.0. Forecoxa white in base color, with whitish microtomentum, with 2 or 3 large setae in addition to a few smaller ones; mid- and hindcoxae with yellow microtomentum; forefemur with only slight swelling in middle, mostly brown with extreme base with yellow

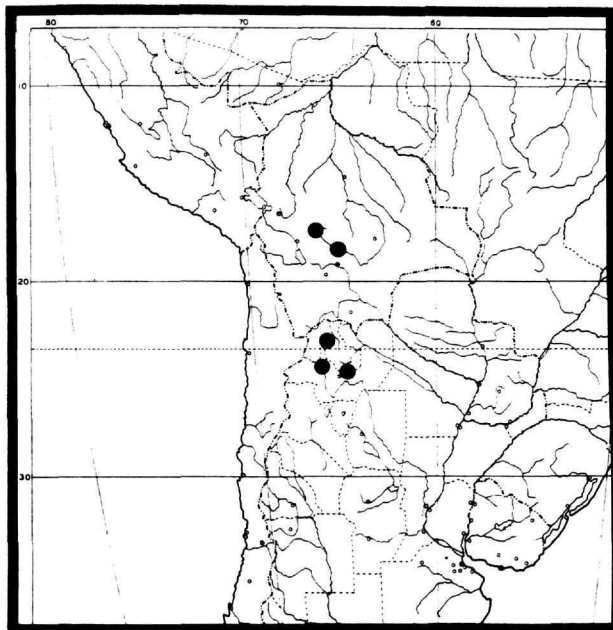

FIGURE 74.—Distribution map for *Masoniella flabella* (dots).

microtomentum and bearing posterodorsal row of setae relatively weak, distal 3 or so slightly stronger, posteroventral row short except for distal 2 or 3, many scattered smaller setae on remainder of posterior surface, otherwise evenly setulose; forefemoral anteroventral ctenidial comb with fewer setae than that of most species of *Pelomyia*, but individual setae relatively strong, shorter than width of foretibia; hindfemur not swollen; mid- and hindfemora with yellow microtomentum, evenly setulose, anterior surface of midfemur with 1 stronger seta in middle; foretibia black, mid- and hindtibiae yellow, microtomentose, evenly setulose; foretarsus brown, mid- and hindtarsi with basal 3 tarsomeres yellow, remainder brown.

Abdomen: Uniformly shiny brown. Male terminalia (Figures 66, 67): ventral lobe of epandrium tapering to a short, blunt point posteriorly, medial surface with a few short, weak setulae; surstylus nearly as long as ventral lobe, narrow, sparsely setulose; aedeagus long, strap-like, narrowed apically, micropubescent over entire length; pregonite fused with hypandrium, leaving only a few setulae on hypandrium; hypandrium stout in lateral view; distal portion of postgonite much reduced, not evident; basiphallus rounded; ejaculatory apodeme with an elongated wide flare. Female terminalia: cercus bearing fine setulae.

TYPE MATERIAL.—The holotype male is labeled “ARGENT[INA]. Salta[:] Rio Juramento, 60km.S. Guemes, 18.X.68. [18 Oct 1968] [L.E.] Pena/HOLOTYP E Masoniella flabella ♂ Foster & W.N.Mathis [red label; species name and ‘♂ and Foster &’ handwritten].” The holotype is glued directly

to the pin, is in excellent condition, and is deposited in the CNC.

Two paratypes (1♂, 1♀; CNC) bear the same label data as the holotype. Other paratypes are as follows: ARGENTINA. *Jujuy*: Agua Caliente (NE Guemes; 1100 m), 18–19 Oct 1968, L.E. Peña (1♀; CNC). *Salta*: Anjuana (3 km N San Carlos), 5 Oct 1968, L.E. Peña (1♂, 3♀; CNC); El Carmen (27 km S Molinos; 1900 m), 6 Oct 1968, L.E. Peña (2♂, 1♀; CNC); Rio San Lucas (N San Carlos; 1800 m), 5–6 Oct 1968, L.E. Peña (1♀; CNC).

BOLIVIA. *Cochabamba*: Cochabamba (17°23.3'S, 65°07'W; 2610 m), 25 Mar 2001, A. Freidberg (3♂, 6♀; USNM).

OTHER SPECIMENS EXAMINED.—ARGENTINA. *Salta*: Rosario de Lerma (Malaise trap, 16–28 Feb 1992, S.A. Marshall (1♀; GUE).

BOLIVIA. *Santa Cruz*: Pampa Grande (swamp), 2 Oct 1996, Bettella and Rossi (1♀; GUE).

DISTRIBUTION (Figure 74).—Neotropical: Argentina (Jujuy, Salta), Bolivia (Cochabamba, Santa Cruz).

ETYMOLOGY.—The species epithet, *flabella*, is of Latin derivation and alludes to the fan-like ejaculatory apodeme of this species.

REMARKS.—This species shows some intermediate forms in two characters of the male terminalia: (1) there is a remnant of a hood that extends from the pregonites over the basiphallus; and (2) the aedeagus is somewhat thickened and more pubescent than for the other species of the genus *Masoniella*.

This species closely resembles *M. richardsi* in habitus, being entirely shiny with delicate shiny legs. It exhibits some setulae on the gena, however, and has only one fronto-orbital seta.

32. *Masoniella richardsi* Vockeroth

FIGURES 68–71, 75

Masoniella richardsi Vockeroth, 1987:1075 [nomen nudum]; 1995:732 [validation].—Mathis and Munari, 1996:13 [world catalog].

DIAGNOSIS.—This species is distinguished from congeners by the following combination of characters: body shiny brown (abdomen darker brown than thorax); frons mostly yellow, dorsal ½ pale brown, bare, with some silvery microtomentum adjacent to ocellar triangle; parafrontal setae absent; fronto-orbital setae 2, reclinate; ocellar triangle with brown microtomentum; antenna entirely yellow; oral vibrissae small, weak; gena 0.08–0.10 times eye height; acrostichal setulae minute, in 4 sparse rows; wing crossveins not infuscate; tarsomeres of normal size; forecoxa yellow in base color with white microtomentum; mid- and hindfemora not swollen; forefemoral anteroventral ctenidial comb of setae short, individual setae moderately strong; apical tarsomeres, especially apical 3, darker brown.

DESCRIPTION.—Body length 1.90–2.05 mm; body entirely shiny brown.

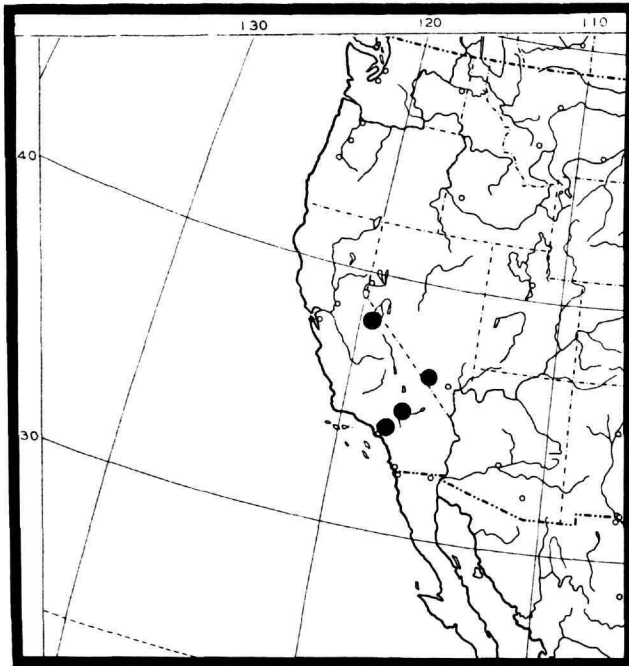

FIGURE 75.—Distribution map for *Masoniella richardsi* (dots).

Head: Ocellar triangle with brown microtomentum; frons mostly yellow, pale brown dorsally, bare, with some silvery microtomentum adjacent to ocellar triangle; parafrons with silvery microtomentum at extreme margins; frontal lunule diminutive, yellow; fronto-orbital seta 1; parafrenal setae absent; ocellar seta 1, strong, ocellar triangle otherwise bare; paraverticilar setae minute, convergent. Antenna entirely yellow, arista pale brown. Gena 0.08–0.10 times eye height, with whitish microtomentum and bearing a row of peristomal setulae, otherwise bare; face narrow, whitish; shiny chitinous stripe along parafacial and peristomal margins; palpus yellow; clypeus yellow.

Thorax: Mesonotum entirely shiny dark brown, pleural surfaces and scutellum shiny pale brown; acrostichal setulae minute, in 4 sparse rows. Wing hyaline; costal section ratios 6.6:2.0:1.0. Forecoxa white in base color, with white microtomentum, with 2 or 3 large setae in addition to a few smaller ones; mid- and hindcoxae with yellow microtomentum; forefemur barely swollen, yellow, subshiny with posterodorsal and posteroventral setae weak but distinct, many scattered smaller setae on remainder of posterior surface, otherwise evenly setulose; forefemoral anteroventral ctenidial comb of setae strong but relatively sparse, shorter than width of foretibia; hindfemur barely swollen; mid- and hindfemora yellow, evenly setulose, no particularly strong seta in middle; foretibia mostly brown, extreme base yellow; mid- and hindtibiae yellow, subshiny, evenly setulose; foretarsus darker brown on apical 3 tarso-

meres, mid- and hindtarsi with basal 3 tarsomeres yellow, remainder brown.

Abdomen: Uniformly shiny, dark brown. Male terminalia (Figures 68–71): ventral lobe of epandrium long, narrowly spatulate, bearing many minute setulae on medial surface; surstylus nearly as long as ventral lobe, narrow, sparsely setulose distally; short anterior lobe present, arising from subepandrial sclerite, with a few minute setulae at apex; aedeagus long, strap-like, flared apically, micropubescent over entire length; pregonite indistinct, fused with hypandrium; hypandrium stout in lateral view; distal portion of postgonite short, rounded, spatulate; basiphallus rounded; ejaculatory apodeme normal; aedeagus long, strap-like, flared at apex, micropubescent along entire length. Female terminalia: cercus bearing long, fine setulae.

TYPE MATERIAL.—The holotype male of *Masoniella richardsi* is labeled “Helendale, Cal[ifornia]. San Bernardino:]. 18-v-1955 [‘18-v’ handwritten; 18 May 1955] W. R. Richards/Masoniella HoloTYPE richardsi Vockeroth CNC No. 17083 Vockeroth [red label; all except ‘TYPE’ and ‘No.’ handwritten]. The holotype is glued directly to the side of a pin, is in excellent condition, and is deposited in the CNC (17083).

Paratypes are as follows: UNITED STATES. *California.* Inyo: China Ranch, 30 May 1955, Belkin et al. (1♂, 1♀; USNM). Los Angeles: Duarte, 20 Nov 1950, N. Ehmann (2♂; USNM). San Bernardino: Helendale, 18 May 1955, W.R.M. Mason (1♂, 1♀; CNC); Victorville, 16 May 1955, W.R. Richards (1♂, 1♀; CNC). *Nevada.* Nye: Ash Meadows National Wildlife Refuge (Crystal Springs; 36°25.2'N, 116°19.8'W), 2 May 2001, D. and W.N. Mathis (6♂, 5♀; USNM).

DISTRIBUTION (Figure 75).—Nearctic: United States (CA, NV).

33. *Masoniella spatulata*, new species

FIGURES 72, 76, 77

DIAGNOSIS.—This species is distinguished from congeners by the following combination of characters: body entirely brown, thorax with brown microtomentum, abdomen shiny; frons mostly yellow, area next to ocellar triangle brownish, a few minute setulae in middle of frons; parafrenal setae sparse, minute; fronto-orbital setae 2, reclinate, anterior seta less than ½ length of posterior seta; ocellar triangle with gray microtomentum; antenna mostly orange with dark area near base of arista; oral vibrissae weak; gena 0.18 times eye height; acrostichal setulae minute, sparse; wing crossveins not infusate; tarsomeres of normal size; forecoxa white in base color with white microtomentum; mid- and hindfemora not swollen; forefemoral anteroventral ctenidial comb of setae short, individual setae relatively strong.

DESCRIPTION.—Body length 1.20 mm; body with thorax brown, microtomentose, abdomen shiny brown.

Head: Ocellar triangle with gray microtomentum; frons mostly yellow, area next to ocellar triangle brownish, a few minute setulae in middle of frons; parafrons with silvery microtomentum at extreme margins; frontal lunule diminutive, yellow; fronto-orbital setae 2, anterior seta less than $\frac{1}{2}$ length of posterior seta; parafrenal setae minute, sparse; ocellar seta 1, well developed, otherwise apparently bare; paravertic setae minute, convergent. Antenna mostly orange, 1st flagellomere orange with small dark area around base of arista. Gena 0.18 times eye height, with whitish microtomentum and bearing a few minute, scattered setulae and row of peristomal setulae; face whitish; shiny chitinous stripe along parafacial and peristomal margins; palpus yellow; clypeus pale brown.

Thorax: Mesonotum with brown microtomentum; acrostichal setulae lacking or minute, sparse. Wing hyaline; vein R_{4+5} ending just behind wing apex; costal section ratios 5.3:1.1:1.0. Forecoxa white in base color, with whitish microtomentum, with 2 or 3 large setae in addition to a few smaller ones; mid- and hindcoxae with yellow microtomentum; forefemur with slight swelling in middle, mostly brown with yellow microtomentum on extreme base, with posterodorsal and posteroventral rows of setae relatively weak but distinct, many scattered smaller setae on remainder of posterior surface, otherwise evenly setulose; forefemoral anteroventral ctenidial comb of setae strong, shorter than width of foretibia; hindfemur not swollen; mid- and hindfemora with yellow microtomentum, evenly setulose, anterior surface of midfemur with one stronger seta in middle; foretibia yellow on basal $\frac{1}{2}$, brown distally; mid- and hindtibiae yellow, microtomentose, evenly setulose; tarsi yellow with $\frac{1}{2}$ of 4th tarsomere and all of 5th tarsomere brown.

Abdomen: Uniformly shiny brown. Male terminalia (Figures 76, 77): ventral lobe of epandrium spatulate, margins smooth, a few setae on medial surface, finely pubescent on lateral surface; surstylus short, straight, setulose at apex; aedeagus long, strap-like, narrowed distally, micropubescent on

basal $\frac{1}{2}$, thin, ribbon-like distally; pregonite fused with hypandrium, leaving only a few setulae on hypandrium; hypandrium stout in lateral view; distal portion of postgonite much reduced, not evident; basiphallus rounded; ejaculatory apodeme widely flared, very weakly sclerotized, except for midrib. Female unknown.

TYPE MATERIAL.—The holotype male is labeled "Chile Chico[,] Lag. Buenos Aires[,] Aysen, CHILE[,] 24–31.XII.'60. [24–31 Dec 1960] [L.E.] Pena/HOLOTYPE Masoniella spatulata ♂ Foster & W.N.Mathis [red label; species name and '♂ Foster &' handwritten]." The holotype (only known specimen) is glued directly to the pin, is in good condition (some setae broken or missing; abdomen removed, dissected, and placed in an attached microvial), and is deposited in the CNC.

DISTRIBUTION (Figure 72).—Neotropical: Chile (Aysén).

ETYMOLOGY.—The species epithet, *spatulata*, is of Latin derivation and alludes to the spatulate ventral lobe of this species.

Phylogenetic Considerations

The subfamily Pelomyiinae, which is one of four subfamilies now placed in the family Tethinidae (Mathis and Munari, 1996), appears similar and closely related to the subfamily Tethininae (Foster, 1976a). The following characters distinguish Pelomyiinae from Tethininae and other subfamilies and confirm the subfamily's monophyly (synapomorphies are noted by an asterisk (*)): (1) fronto-orbital setae usually with similar orientation, mostly reclinate or laterocline; (2) paravertic setae more or less convergent; (*3) gena setose; (4) clypeus small, if exposed, not protruding anteriorly beyond oral margin; (5) maxillary palpus and proboscis not shortened; (*6) acrostichal setae reduced or absent; (7) wing not conspicuously long and narrow (typically about 2× longer than wide); (8) costa not spinose; (*9) crossvein $bm-cu$ generally absent; (10) vein $A_1 + CuA_2$ short, much shorter than discal cell; (11) tergites wider than long; (12) tergite 6 well differentiated from short syntergosternite 7 + 8; (*13) dorsal shift of surstylus; and (*14) complex internal copulatory apparatus.

With the composition and monophyly of the subfamily Pelomyiinae well established, the cladistic relationships within this subfamily were our next objective. This analysis was done in two steps, the first of which focused on the relationships among the four genera (*Masoniella*, *Neopelomyia*, *Pelomyia*, *Pelomyiella*) composing Pelomyiinae. For this portion of the cladistic analysis, we discovered and analyzed 19 characters, the numbers for which correspond with those in the character matrix for these genera (Table 1) and the cladogram illustrating their relationships (Figure 78). In the character list that follows, zero (0) indicates a state of the outgroup, which was the genus *Tethina* in this phylogenetic analysis.

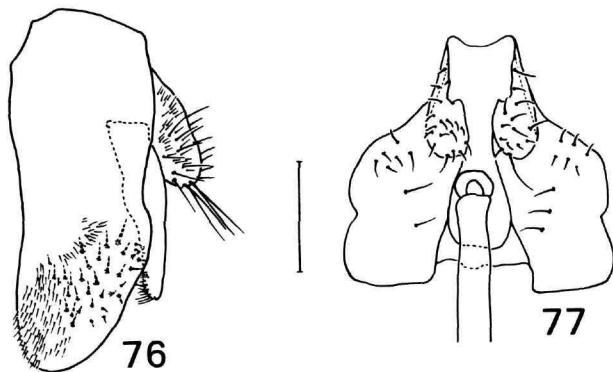

FIGURES 76, 77.—*Masoniella spatulata*: 76, external male terminalia (epandrium, cercus, surstylus), lateral aspect; 77, hypandrium, ventral aspect. Scale bar = 0.1 mm.

CHARACTERS USED IN THE PHYLOGENETIC ANALYSIS
OF THE FOUR GENERA WITHIN SUBFAMILY PELOMYIINAE

General

1. Body size: (0) robust; (1) small, delicate (an autapomorphy for *Masoniella*).
2. Body vestiture: (0) generally microtomentose; (1) generally shiny (an autapomorphy for *Masoniella*).

Head

3. Number of fronto-orbital setae: (0) 2 or 3 (*Pelomyiella*, *Neopelomyia*, and *Tethina*); (1) 1 (a synapomorphy for *Pelomyia* and *Masoniella*).
4. Orientation of paravertical setae: (0) inclinate and convergent; (1) proclinate (a synapomorphy for *Neopelomyia* and *Pelomyiella*).
5. Peristomal, shiny stripe: (0) absent; (1) present (a synapomorphy for *Pelomyia* and *Masoniella*).
6. Gena: (0) bare; (1) setose (an autapomorphy for Pelomyiinae).
7. Shape of head: (0) at least as high as long; (1) elongate, clearly longer than high (an autapomorphy for *Neopelomyia*; occurs convergently in some *Tethina*).
8. Shape of face: (0) vertical; (1) protrudent (an autapomorphy for *Neopelomyia*).
9. Number of maxillary palpal setae: (0) many scattered along length of maxillary palpus (*Pelomyiella*, *Neopelomyia*, and *Tethina*); (1) only 1 seta, strong, apical (a synapomorphy for *Pelomyia* and *Masoniella*).

Thorax

10. Forefemoral anteroventral ctenidial comb of setae: (0) absent; (1) present (a synapomorphy for *Masoniella* and *Pelomyia*; also apparently present secondarily in most species of *Dasyrhicnoessa*).
11. Crossvein bm-cu: (0) present; (1) absent (an autapomorphy for Pelomyiinae).
12. Acrostichal setae: (0) numerous (usually 4 rows of many setae); (1) reduced (2 uneven rows) or absent (an autapomorphy for Pelomyiinae).

Abdomen

13. Postgonites: (0) separate; (1) fused or nearly so (a synapomorphy for *Neopelomyia* and *Pelomyiella*).
14. Postgonites: (0) simple: lacking nodulate flexion zones and additional lobes, and not extended posteriorly; (1) complex: well developed, may be bilobed, often with a nodulate flexion zone in middle, and may be extended and pointed posteriorly (an autapomorphy for *Pelomyia*).
15. Flexion zone on postgonite: (0) absent; (1) present with nodulate flexion zone (a synapomorphy for *Masoniella* and *Pelomyia*).

TABLE 1.—Matrix of characters and taxa used in the cladistic analysis of the four genera of Pelomyiinae. Numbers for the 19 characters and their states correspond with those used in the text. *Tethina* (subfamily Tethininae) is the out-group for this analysis.

| Genus | State of character | | | | | | | | | | | | | | | | | | |
|--------------------|--------------------|---|---|---|---|---|---|---|---|----|----|----|----|----|----|----|----|----|----|
| | 1 | 2 | 3 | 4 | 5 | 6 | 7 | 8 | 9 | 10 | 11 | 12 | 13 | 14 | 15 | 16 | 17 | 18 | 19 |
| <i>Tethina</i> | 0 | 0 | 0 | 0 | 0 | 0 | 0 | 0 | 0 | 0 | 0 | 0 | 0 | 0 | 0 | 0 | 0 | 0 | 0 |
| <i>Masoniella</i> | 1 | 1 | 1 | 0 | 1 | 1 | 0 | 0 | 1 | 1 | 1 | 1 | 0 | 0 | 1 | 1 | 0 | 1 | 1 |
| <i>Pelomyia</i> | 0 | 0 | 1 | 0 | 1 | 1 | 0 | 0 | 1 | 1 | 1 | 1 | 0 | 1 | 1 | 1 | 1 | 1 | 1 |
| <i>Pelomyiella</i> | 0 | 0 | 0 | 1 | 0 | 1 | 0 | 0 | 0 | 0 | 1 | 1 | 1 | 0 | 0 | 0 | 0 | 1 | 1 |
| <i>Neopelomyia</i> | 0 | 0 | 0 | 1 | 0 | 1 | 1 | 1 | 0 | 0 | 1 | 1 | 1 | 0 | 0 | 0 | 0 | 1 | 1 |

16. Shape of basiphallus: (0) round; (1) long, pointed, triangular (a synapomorphy for *Masoniella* and *Pelomyia*).
17. Shape of hypandrium in lateral view: (0) wide; (1) narrow (an autapomorphy for *Pelomyia*).
18. Position of surstylus: (0) ventral; (1) shifted dorsally (an autapomorphy for Pelomyiinae).
19. Internal copulatory apparatus: (0) simple; (1) complex: postgonites distinct, long, and often flexible, occasionally branched; basiphallus enlarged, often dentate; pregonites distinct (an autapomorphy for Pelomyiinae).

By using the implicit enumeration (ie*) option of Hennig86, we conducted an exhaustive search to generate a single most-parsimonious tree from the analysis of the 19 characters. The cladogram (Figure 78) has a length of 11 steps and perfect consistency and retention indices (1.00 and 1.00, respectively).

As indicated on the cladogram (Figure 78), the subfamily Pelomyiinae is divided into two clades. The first clade comprises *Pelomyiella* and *Neopelomyia*, and the second—the sister group to the first clade—includes *Masoniella* and *Pelomyia*. The latter two genera are indeed closely related and similar to each other, and earlier, as this research was developing, we considered combining them. With evidence that the two clades are monophyletic, we now advocate keeping these two genera separate, especially because they are usually easily distinguished and recognizable in the field.

The second object of the cladistic analysis was focused on species groups within *Pelomyia*. For this study, seven characters were analyzed. Table 2 is the matrix showing the character states for each *Pelomyia* species in the analysis.

CHARACTERS USED IN THE PHYLOGENETIC ANALYSIS
OF SPECIES GROUPS WITHIN *PELOMYIA*

Head

1. Number of fronto-orbital setae: (0) 2 or more; (1) 1.
2. Clypeal color: (0) gray; (1) brown (a synapomorphy for *P. coronata*, *P. occidentalis*, *P. nubila*, *P. planibulla*, *P. lobina*, and *P. intermedia*); (2) dark brown (a synapomorphy for *P. crassiseta* and *P. crassispinata*); (3) dark gray or black (an autapomorphy of *Pelomyiella*); (4) brown (secondarily, a reversal, *P. viedmae*).

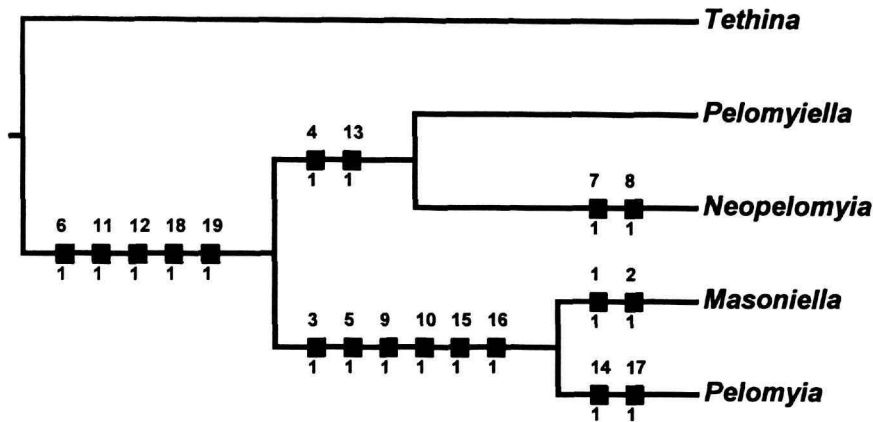

FIGURE 78.—Cladogram depicting hypothetical cladistic relationships among genera of Pelomyiinae (squares indicate synapomorphies and/or autapomorphies).

Thorax

3. Forecoxal base color: (0) dark; (1) white or yellow (a synapomorphy for *P. coronata*, *P. occidentalis*, *P. nubila*, *P. planibulla*, *P. lobina*, and *P. intermedia*; secondarily for *P. crassispina*).
4. Foretibial color: (0) evenly colored; (1) bicolored, yellowish basally, dark (gray or brown) apically (a synapomorphy for *P. occidentalis*, *P. nubila*, *P. planibulla*, *P. lobina*, and *P. intermedia*); (2) evenly brown colored secondarily (*P. coronata*); (3) secondarily bicolored (*P. dentata*).
5. Mid- and hindtarsal color: (0) evenly colored; (1) distal 2 or 3 tarsomeres brown, basal tarsomeres yellow (a synapomorphy for *P. coronata*, *P. occidentalis*, *P. nubila*, and *P. lobina*; secondarily for *P. crassispina*).
6. Crossvein bm-cu: (0) absent; (1) at least partially present (a synapomorphy for *P. grisecoxia*, *P. crassiseta*, *P. crassispina*, and *P. melanocera*).

Abdomen

7. Nodulate flexion zone of postgonite: (0) present; (1) secondarily simple (a synapomorphy for *P. grisecoxia*, *P. crassiseta*, *P. crassispina*, and *P. melanocera*).

We again performed an exhaustive search, using the implicit enumeration (ie*) option of Hennig86, to generate two equally parsimonious trees from the analysis. Each of these cladograms is 13 steps in length, and both have consistency and retention indices of 0.84 and 0.92, respectively. The matrix was then subjected iteratively to successive weighing (xs w, ie*, cc) to determine a character's contribution or weight (Carpenter, 1988; Dietrich and McKamey, 1995). The successive weighing stabilized at 104 steps and resulted in two trees. The analysis of the characters for the cladogram is shown in Table 3, and the

weights of the various characters are shown in Table 4. Given these character weights, the analysis of the cladogram resulted in revised consistency and retention indices of 0.93 and 0.96, respectively. We then determined agreement among branches

TABLE 2.—Matrix of characters and taxa used in the cladistic analysis of 25 of 26 described species¹ of *Pelomyia*. The seven characters and their states are defined in the text. Genus *Pelomyiella* is included in the analysis as the outgroup.

| Taxon | State of character | | | | | | |
|---------------------------|--------------------|------|----|---|--|--|--|
| | 12 | 34 | 56 | 7 | | | |
| <i>Pelomyiella</i> | 03 | 0000 | 0 | | | | |
| 1. <i>P. coronata</i> | 11 | 1210 | 0 | | | | |
| 5. <i>P. occidentalis</i> | 11 | 1110 | 0 | | | | |
| 4. <i>P. nubila</i> | 11 | 1110 | 0 | | | | |
| 7. <i>P. planibulla</i> | 11 | 1100 | 0 | | | | |
| 3. <i>P. lobina</i> | 11 | 1110 | 0 | | | | |
| 6. <i>P. intermedia</i> | 11 | 1100 | 0 | | | | |
| 25. <i>P. grisecoxia</i> | 00 | 0001 | 1 | | | | |
| 23. <i>P. crassiseta</i> | 02 | 0001 | 1 | | | | |
| 24. <i>P. crassispina</i> | 02 | 1011 | 1 | | | | |
| 26. <i>P. melanocera</i> | 00 | 0001 | 1 | | | | |
| 16. <i>P. vockerothi</i> | 10 | 0000 | 0 | | | | |
| 17. <i>P. freidbergi</i> | 10 | 0000 | 0 | | | | |
| 18. <i>P. curva</i> | 10 | 0000 | 0 | | | | |
| 19. <i>P. univittata</i> | 10 | 0000 | 0 | | | | |
| 20. <i>P. nigripalpis</i> | 10 | 0000 | 0 | | | | |
| 21. <i>P. undulata</i> | 10 | 0000 | 0 | | | | |
| 22. <i>P. boliviensis</i> | 10 | 0000 | 0 | | | | |
| 12. <i>P. peruviana</i> | 10 | 0000 | 0 | | | | |
| 14. <i>P. trivittata</i> | 10 | 0000 | 0 | | | | |
| 9. <i>P. aurantifrons</i> | 10 | 0000 | 0 | | | | |
| 10. <i>P. irwini</i> | 10 | 0000 | 0 | | | | |
| 15. <i>P. viedmae</i> | 14 | 0000 | 0 | | | | |
| 11. <i>P. nigratarsis</i> | 10 | 0000 | 0 | | | | |
| 8. <i>P. dentata</i> | 10 | 0300 | 0 | | | | |
| 13. <i>P. robustiseta</i> | 10 | 0000 | 0 | | | | |

¹ *Pelomyia granditarsa* is not included because it is represented by a poorly preserved male specimen.

TABLE 3.—Analysis of characters based on the cladogram for species groups of *Pelomyia* (see Figure 79).

| Character | 1 | 2 | 3 | 4 | 5 | 6 | 7 |
|-------------------|-----|-----|----|-----|----|-----|-----|
| Steps | 1 | 4 | 2 | 2 | 2 | 1 | 1 |
| Consistency index | 100 | 100 | 50 | 100 | 50 | 100 | 100 |
| Retention index | 100 | 100 | 80 | 100 | 75 | 100 | 100 |

TABLE 4.—Weight (variable from 1 to 10) and status¹ (additive, +; nonadditive, -) of characters after successive weighing.

| Character | 1 | 2 | 3 | 4 | 5 | 6 | 7 |
|----------------|------|-----|-----|-----|-----|------|-----|
| Weight, status | 10+, | 10- | 4+, | 10- | 3+, | 10+, | 10+ |

¹ Status of all characters was active.

of the two trees by using a strict consensus utility (nelsen). The consensus tree is identical with one of the first two trees and is our cladogram of choice (Figure 79).

Although the cladogram comprises numerous unresolved relationships and lineages, some cladogenetic structure is evident

at the species-group level. The two basal clades are monophyletic and are the basis for the two species groups that we recognize. The *melanocera* group is characterized by two unambiguous synapomorphies (characters 6 and 7). Within this species group, which comprises just five species, *P. crassiseta* and *P. crassispina* are more closely related to each other than either is to the other two species of the group. The sister-group relationship between these two species, however, is corroborated by only a single synapomorphy (character 2, state 2).

The *coronata* group is much larger than the *melanocera* group and now includes 22 species. With one exception, we were unable to discover any phylogenetic structure among these species, and this species group is primarily a bush of single species. The exception is the relationship of six species including *P. coronata*. This group is characterized by three synapomorphies (characters 2, 3, and 4). Four species (*P. coronata*, *P. lobina*, *P. nubila*, and *P. occidentalis*) within this group of six form a lineage that is characterized by a single synapomorphy (character 5).

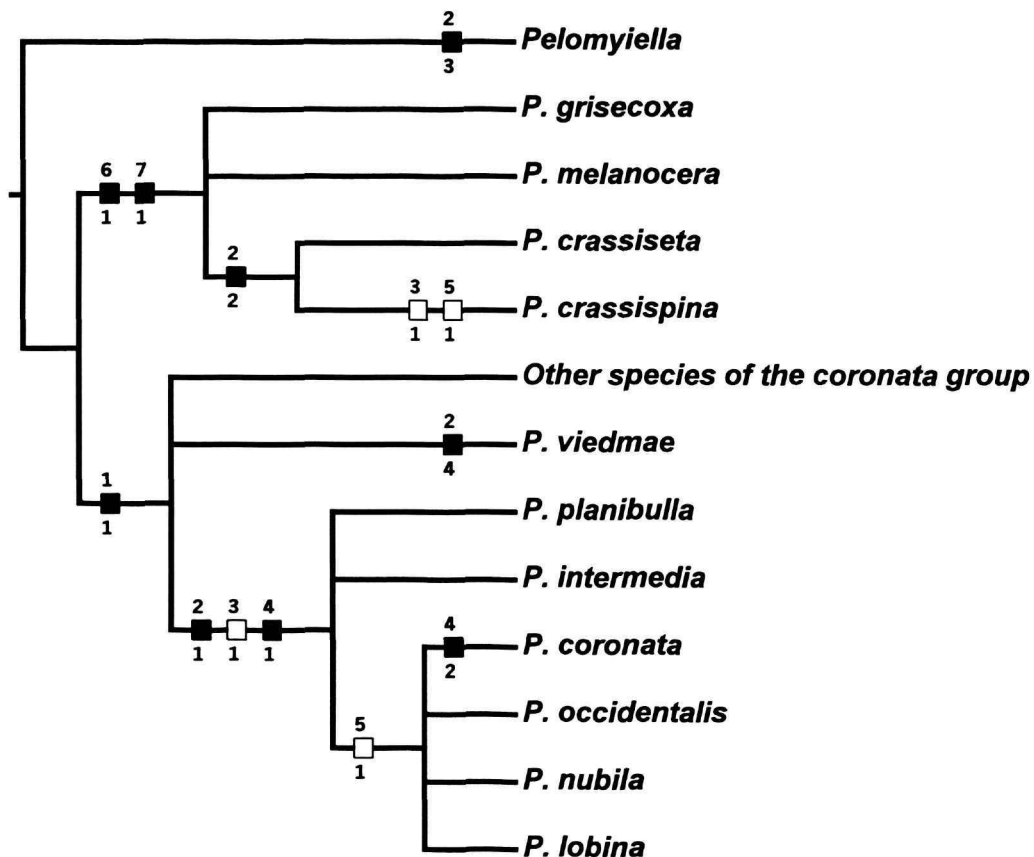

FIGURE 79.—Cladogram depicting hypothetical cladistic relationships among species groups of *Pelomyia* (open squares indicate ambiguous synapomorphies; solid squares indicate unambiguous synapomorphies and/or autapomorphies).

DISTRIBUTIONAL AND BIOGEOGRAPHIC CONSIDERATIONS

Pelomyia occidentalis now has a Holarctic distribution and also occurs on Hawaii (Oahu), where it was first recorded in 1946 and which is the first record of *P. occidentalis* outside of North America. Some locality records from the western Palearctic Region share an association with military operations (A.G. Irwin, in litt. to W.N.M., 2001). The first record from Europe (1960) is Lüneburger Heide, a military training range well used by United States forces; and the first British site, Walton-on-Naze, is close to a wartime military establishment. Whether a United States military presence was near any of the Eastern European localities is unknown. Regardless, we concur with Roháček (1992) and Irwin et al. (2001) that this species was probably introduced to central Europe, perhaps in the 1950s. This species was probably also introduced to Hawaii and appears particularly prone to being introduced. Irwin (in litt. to W.N.M., 2001), for example, observed that there are few North American records for *P. occidentalis* or *P. coronata* from east of 100° W longitude, which could reflect either sampling error or the real distribution. If real, the paucity of records from the eastern United States may indicate that these species are in fact western species that have been introduced to the eastern states, perhaps like *P. occidentalis* was introduced to Hawaii and Europe. Unfortunately, we know virtually nothing about the life history of these species and thus are clueless about potential mechanisms for introduction. The only hint of evidence available to us is that a single specimen of *P. occidentalis* was collected on lettuce at a supermarket in Maryland.

Most species of *Pelomyia*, whether occurring in the New or Old Worlds, are primarily found in areas with temperate climates. In the neotropics, where there is considerable species diversity in *Pelomyia* and *Masoniella*, specimens were often found at higher elevations, sometimes exceeding 4000 m. This ecological zone is generally referred to as the Puna (or “Provincia Puneña”; Cabrera and Willink, 1973) and is found primarily in northern Argentina (Jujuy and Salta) and adjacent areas of

Bolivia and Chile. The Puna is characterized by its high altitude (3200–4400 m), relative dryness (less than 50 mm to about 700 mm of precipitation in a transition from north to south), and generally cool to cold temperatures (median annual temperatures of 8.5°–9.5°C) that vacillate greatly from night to day. Other notable features of the Puna region in northern Argentina and Bolivia are the salt lakes and associated playas with their characteristic, saline-tolerant floras and faunas. Many specimens of both *Pelomyia* and *Masoniella* are from localities in the Puna and presumably were collected from grass and pasture lands, often sparsely vegetated, near sources of moisture, such as the saline lakes and marsh lands.

In central Chile, which also yielded many specimens and which is a different ecological zone, the specimens of *Pelomyia* and *Masoniella* are again from temperate zones, often at high elevations.

Collecting for Tethinidae in Argentina and Chile is woefully deficient, with a single collector, Luis “Lucho” E. Peña, contributing most of the effort. Although Lucho was an exceptional naturalist generally and field entomologist specifically, many of these areas were not sampled by a specialist. Collecting specifically for tethinids in these areas and in other temperate zones of the neotropics will undoubtedly yield additional specimens and new species. One recent example underscores the need for better sampling by specialists. Amnon Freidberg and Wayne Mathis spent three weeks in Bolivia during March 2001. Although that expedition was primarily for field work in the Yungas, or highlands, of Bolivia, they were able to spend a few days on the Altiplano. Their sampling for Tethinidae during those few days on the Altiplano resulted in 12 species, all new country records, including six that are new species! Our sampling from Peru and Ecuador is even more meager, and between Mexico and Ecuador virtually no specimens are available. Obviously, we can anticipate numerous new species and substantial additions to the distributions of known species with better sampling of the neotropics.

Literature Cited

- Ardö, P.
1957. Studies in the Marine Shore Dune Ecosystem with Special Reference to the Dipterous Fauna. *Opuscula Entomologica, Supplementum*, 14:1–255, 82 figures, 9 tables.
- Becker, T.
1896. Dipterologische Studien IV: Ephyridae. *Berliner Entomologische Zeitschrift*, 41(2):91–276, 4 plates.
- Cabrera, A.L., and A. Willink
1973. *Biogeografía de América Latina*. 120 pages. Washington, D.C.: Programa Regional de Desarrollo Científico y Tecnológico, Departamento de Asuntos Científicos, Organización de los Estados Americanos.
- Carpenter, J.M.
1988. Choosing among Multiple Equally Parsimonious Cladograms. *Cladistics*, 4(3):291–296.
- Cole, F.R. (with the collaboration of E.T. Schlinger)
1969. *The Flies of Western North America*. xi+693 pages, 360 figures. Berkeley and Los Angeles: University of California Press.
- Cumming, J.M., B.J. Sinclair, and D.M. Wood
1995. Homology and Phylogenetic Implications of Male Genitalia in Diptera—Eremoneura. *Entomologica Scandinavica*, 26:120–151, 20 figures.
- Curran, C.H.
1934. *The Families and Genera of North American Diptera*. 512 pages. New York: The Ballou Press.
- Czerny, L.
1928. 55, Tethinidae. In E. Lindner, editor, *Die Fliegen der Palaearktischen Region*, 5(2):1–8, 5 figures. Stuttgart.
- Dietrich, C.H., and S.H. McKamey
1995. Two New Neotropical Treehopper Genera and Investigation of the Phylogeny of the Subfamily Membracinae (Homoptera: Membracidae). *Proceedings of the Entomological Society of Washington*, 97(1):1–16.
- Foster, G.A.
1976a. Notes on the Phylogeny of the Nearctic Tethinidae and a Review of the Genus *Neopelomyia* Hendel, and the *Tethina milichioides* Group (Diptera). *Proceedings of the Entomological Society of Washington*, 78(3):336–352, 17 figures.
1976b. 74, Family Tethinidae. In N. Papavero, editor, *A Catalogue of the Diptera of the Americas South of the United States*. 4 pages. São Paulo: Museu de Zoologia, Universidade de São Paulo.
- Freidberg, A., and V. Beschovski
1996. A New Species Group within *Tethina* Haliday (Diptera: Tethinidae) with Descriptions of Six New Mediterranean Species. *Israel Journal of Entomology*, 30:91–113, 36 figures.
- Haliday, A.H.
1838. New British Insects Indicated in Mr. Curtis's Guide [part]. *Annals and Magazine of Natural History*, 2:183–190.
- Hardy, D.E., and M.D. Delfinado
1980. Tethinidae. In D.E. Hardy and M.D. Delfinado, editors, *Insects of Hawaii*, volume 13, pages 369–379. Honolulu: University Press of Hawaii.
- Hendel, F.
1911. Über von Professor J.M. Aldrich erhaltene und einige andere amerikanische Dipteren. *Wiener Entomologische Zeitung*, 30(2–3):19–46, 4 figures.
1917. Beiträge zur Kenntnis der acalypraten Musciden. *Deutsche Entomologische Zeitschrift*, 1917(1):33–47, 3 figures.
1934. Revision der Tethiniden (Dipt. Muscid. acal.). *Tijdschrift voor Entomologie*, 77:37–54.
- Hennig, W.
1937 (“1936”). Systematisch-tiergeographische Beiträge zur Kenntnis der Tethiniden (Dipt., Acalypt.). *Entomologischen Rundschau*, 54(9):136–140, 3 figures. [Date on paper is 1936; actually published in 1937.]
1939. Beiträge zur Kenntnis des Kopulationsapparates und der Systematik der Acalypraten, II: Tethinidae, Milichiidae, Anthomyzidae und Opomyzidae (Diptera). *Arbeiten über Morphologische und Taxonomische Entomologie aus Berlin-Dahlem*, 6(2):81–94.
- Irwin, A.G., J.H. Cole, and W.A. Ely
2001. *Pelomyia occidentalis* Williston (Dip.: Tethinidae) New to Britain and Germany. *Entomologist's Record and Journal of Variation*, 113:153–156, 2 figures.
- Kuntze, A.
1897. II, *Tethina illota* Hal. *Abhandlungen der Naturwissenschaftlichen Gesellschaft Isis in Dresden*, 1897:19–20.
- Loew, H.
1866 (“1865”). Diptera Americae septentrionalis indigena. Centuria sexta. *Berliner Entomologische Zeitschrift*, 9:127–186. [Date on title page is 1865; actually published in 1866.]
- Malloch, J.R.
1913. A Synopsis of the Genera of Agromyzidae, with Descriptions of New Genera and Species. *Proceedings of the United States National Museum*, 46:127–154, plates 4–6.
1934. Tethinidae. In F.W. Edwards, editor, *Diptera of Patagonia and South Chile*, 6(5):452–460. London: British Museum (Natural History).
- Mathis, W.N., and M. Sasakawa
1989. 102, Family Tethinidae. In N.L. Evenhuis, editor, *Catalog of the Diptera of the Australasian and Oceanian Regions*, pages 667–668, 803–804. Honolulu: E.J. Brill and B.P. Bishop Museum special publication 86.
- Mathis, W.N., and L. Munari
1996. World Catalog of the Family Tethinidae (Diptera). *Smithsonian Contributions to Zoology*, 584:1–27, 1 figure.
- McAlpine, J.F.
1981. Morphology and Terminology—Adults. In J.F. McAlpine et al., editors, *Manual of Nearctic Diptera*, 1:9–63, 146 figures. Ottawa: Research Branch, Agriculture Canada, Monograph 27.
- Melander, A.L.
1913a. A Synopsis of the Dipterous Groups Agromyzinae, Milichinae, Ochthiphilinae and Geomyzinae. *Journal of the New York Entomological Society*, 21(3):219–273.
1913b. A Synopsis of the Dipterous Groups Agromyzinae, Milichinae, Ochthiphilinae and Geomyzinae. *Journal of the New York Entomological Society*, 21(4):283–300, 8 figures.
1952. The North American Species of Tethinidae (Diptera). *Journal of the New York Entomological Society*, 59:187–212, 6 figures.
- Roháčec, J.
1992. Tethinidae (Diptera) of Czechoslovakia: A Faunistic Survey. *Casopis Slezského Zemského Muzea v Opava* (series A), 41:127–131.
- Séguy, E.
1934. Diptères (Brachycères) (Muscidae Acalypterae et Scatophagidae). *Faune de France*, 28:1–832, 27 plates. Paris: Paul Lechevalier.
- Stackelberg, A.A.
1970. 90, Family Tethinidae. In G. Ya. Bei-Bienko, editor [Keys to the Insects of the European Part of the USSR; Diptera and Siphonaptera], 5(2):355–356. Leningrad: Zoological Institute, Akademiia Nauk SSR. [In Russian; English translation published in 1988 by the Smith-

- sonian Institution Libraries and the National Science Foundation. New Delhi: Amerind Publishing Company, Pvt. Ltd.; Tethinidae is treated on pages 591–592.]
- Sturtevant, A.H.
1923. New Species and Notes on Synonymy and Distribution of Muscidae Acalypteratae (Diptera). *American Museum Novitates*, 76:1–12.
- Szadziewski, R.
1983. Flies (Diptera) of the Saline Habitats of Poland. *Polskie Pismo Entomologiczne*, 53:31–76, 20 figures, 2 tables.
- Trojan, P.
1962. Odiniidae, Clusiidae, Anthomyzidae, Opomyzidae, Tethinidae. *Klucze do Oznaczania Owadów Polski*, 28(54–58):1–68.
- Vockerth, J.R.
1965. Family Tethinidae. In A. Stone et al., editors, *A Catalog of the Diptera of America North of Mexico*, pages 726–728. Washington, D.C.: USDA Agricultural Handbook 276.
1987. 101, Tethinidae. In J.F. McAlpine, editor, *Manual of Nearctic Diptera*, 2:1073–1078, 14 figures. Ottawa: Research Branch, Agriculture Canada, Monograph 28.
1995. Validation of *Nomina Nuda* of Nearctic Tethinidae, Scathophagidae, and Muscidae Proposed in Manual of Nearctic Diptera. *Proceedings of the Entomological Society of Washington*, 97(3):732–734.
- Williston, S.W.
1893. List of Diptera of the Death Valley Expedition. *North American Fauna*, 7:253–259.
1908. *Manual of North American Diptera*. Third edition, 405 pages, 163 figures. New Haven: James T. Hathaway.
- Zuska, J., and P. Laštovka
1969. Species-Composition of the Dipterous Fauna in Various Types of Food-Processing Plants in Czechoslovakia. *Acta Entomologica Bohemoslovaca*, 66:201–221.

REQUIREMENTS FOR SMITHSONIAN SERIES PUBLICATION

Manuscripts intended for series publication receive substantive review (conducted by their originating Smithsonian museums or offices) and are submitted to the Smithsonian Institution Press with Form SI-36, which must show the approval of the appropriate authority designated by the sponsoring organizational unit. Requests for special treatment—use of color, foldouts, case-bound covers, etc.—require, on the same form, the added approval of the sponsoring authority.

Review of manuscripts and art by the Press for requirements of series format and style, completeness and clarity of copy, and arrangement of all material, as outlined below, will govern, within the judgment of the Press, acceptance or rejection of manuscripts and art.

Copy must be prepared on typewriter or word processor, double-spaced, on one side of standard white bond paper (not erasable), with 1 1/4" margins, submitted as ribbon copy (not carbon or xerox), in loose sheets (not stapled or bound), and accompanied by original art. Minimum acceptable length is 30 pages.

Front matter (preceding the text) should include: **title** page with only title and author and no other information; **abstract** page with author, title, series, etc., following the established format; table of **contents** with indents reflecting the hierarchy of heads in the paper; also, **foreword** and/or **preface**, if appropriate.

First page of text should carry the title and author at the top of the page; **second page** should have only the author's name and professional mailing address, to be used as an unnumbered footnote on the first page of printed text.

Center heads of whatever level should be typed with initial caps of major words, with extra space above and below the head, but no other preparation (such as all caps or underline, except for the underline necessary for generic and specific epithets). Run-in paragraph heads should use period/dashes or colons as necessary.

Tabulations within text (lists of data, often in parallel columns) can be typed on the text page where they occur, but they should not contain rules or numbered table captions.

Formal tables (numbered, with captions, boxheads, stubs, rules) should be submitted as carefully typed, double-spaced copy separate from the text; they will be typeset unless otherwise requested. If camera-copy use is anticipated, do not draw rules on manuscript copy.

Taxonomic keys in natural history papers should use the aligned-couplet form for zoology and may use the multi-level indent form for botany. If cross referencing is required between key and text, do not include page references within the key, but number the keyed-out taxa, using the same numbers with their corresponding heads in the text.

Synonymy in zoology must use the short form (taxon, author, year:page), with full reference at the end of the paper under "Literature Cited." For botany, the long form (taxon, author, abbreviated journal or book title, volume, page, year, with no reference in "Literature Cited") is optional.

Text-reference system (author, year:page used within the text, with full citation in "Literature Cited" at the end of the text) must be used in place of bibliographic footnotes in all Contributions Series and is strongly recommended in the Studies Series: "(Jones, 1910:122)" or "...Jones (1910:122)." If bibliographic footnotes are

required, use the short form (author, brief title, page) with the full citation in the bibliography.

Footnotes, when few in number, whether annotative or bibliographic, should be typed on separate sheets and inserted immediately after the text pages on which the references occur. Extensive notes must be gathered together and placed at the end of the text in a notes section.

Bibliography, depending upon use, is termed "Literature Cited," "References," or "Bibliography." Spell out titles of books, articles, journals, and monographic series. For book and article titles use sentence-style capitalization according to the rules of the language employed (exception: capitalize all major words in English). For journal and series titles, capitalize the initial word and all subsequent words except articles, conjunctions, and prepositions. Transliterate languages that use a non-Roman alphabet according to the Library of Congress system. Underline (for italics) titles of journals and series and titles of books that are not part of a series. Use the parentheses/colon system for volume (number):pagination: "10(2):5-9." For alignment and arrangement of elements, follow the format of recent publications in the series for which the manuscript is intended. Guidelines for preparing bibliography may be secured from Series Section, SI Press.

Legends for illustrations must be submitted at the end of the manuscript, with as many legends typed, double-spaced, to a page as convenient.

Illustrations must be submitted as original art (not copies) accompanying, but separate from, the manuscript. Guidelines for preparing art may be secured from the Series Section, SI Press. All types of illustrations (photographs, line drawings, maps, etc.) may be intermixed throughout the printed text. They should be termed **Figures** and should be numbered consecutively as they will appear in the monograph. If several illustrations are treated as components of a single composite figure, they should be designated by lowercase italic letters on the illustration; also, in the legend and in text references the italic letters (underlined in copy) should be used: "Figure 9b." Illustrations that are intended to follow the printed text may be termed **Plates**, and any components should be similarly lettered and referenced: "Plate 9b." Keys to any symbols within an illustration should appear on the art rather than in the legend.

Some points of style: Do not use periods after such abbreviations as "mm, ft, USNM, NNE." Spell out numbers "one" through "nine" in expository text, but use digits in all other cases if possible. Use of the metric system of measurement is preferable; where use of the English system is unavoidable, supply metric equivalents in parentheses. Use the decimal system for precise measurements and relationships, common fractions for approximations. Use day/month/year sequence for dates: "9 April 1976." For months in tabular listings or data sections, use three-letter abbreviations with no periods: "Jan, Mar, Jun," etc. Omit space between initials of a personal name: "J.B. Jones."

Arrange and paginate sequentially every sheet of manuscript in the following order: (1) title page, (2) abstract, (3) contents, (4) foreword and/or preface, (5) text, (6) appendices, (7) notes section, (8) glossary, (9) bibliography, (10) legends, (11) tables. Index copy may be submitted at page proof stage, but plans for an index should be indicated when the manuscript is submitted.

